

6700
SERIES

6789

6700 Series 7" handsfree video monitor for the "true" 2 wire BUS VX2300 digital system

 **VX2300**



The **6789** colour handsfree video monitor is a surface mount monitor incorporating a 7" hi-res full colour LCD capacitive touch screen in a white finish and for use on the VX2300 digital system.

It incorporates a multitude of features some of which include Wi-Fi capability, a temperature & humidity sensor, programmable weather widget, event logging feature, integration of 3rd party devices, display language selection and many more.

7" TFT LCD video monitor

6700 series handsfree video monitor with high resolution and capacitive touch screen and OSD menu.

Handsfree operation

Full-duplex handsfree speech.

4 push buttons

Four freely configurable buttons.

Sensors

High quality integrated temperature sensor (smart chronothermostat).

Intercommunication function

Make intercommunication calls between other video monitors via the GUI (graphical user interface).

Adjustments

Microphone & speaker volume adjustments and onscreen contrast and brightness controls.

Can be mounted onto a table top using a desktop kit



7" TFT LCD



TOUCH SCREEN





















HANDSFREE

 **VIDEX**[®]

THE POWER TO SECURE

Additional Key Features

-  Wi-Fi capability that allows a connection to the internet.
-  Select OSD language: English, Italian, French, Spanish, German, Norwegian or Portuguese.
-  Weather widget that enables you to set the desired location for weather information.
-  Smart scheduling for the thermostat feature that allows you to setup 10 weekly programs.
-  Intercommunication facility between other video monitors on the system through the GUI.
-  Events log feature which can be enabled or disabled and exported as a PDF or CSV file.
-  Advanced features include downloading captured screenshots, audio & video recordings.
-  CCTV implementation with PIP (picture in picture) capability.
-  Programmable ringtones (10 available), number of rings (1 to 10 rings) and local bell ringtone.
-  Date & Time feature that enables you to set the timezone or manually set the date & time.
-  3rd Party Integration that enables 3rd party devices to be connected to the video monitor.
-  High quality thermostat & humidity sensor allowing for temperature calibration.
-  Connect the video monitor to the VIDEX **CloudNected** framework & smartphone app.
-  Adjust the device settings via the **IPure Wizard** software or via the internal web browser function.
-  RTSP & HTTP protocols supported, accessible via the **IPure Wizard** or the internal web browser.
-  Screen cleaning function that enables you to disable the touch display for cleaning the screen.
-  General settings include: mic & speaker volume adjustments, brightness and contrast controls.
-  Privacy function including programmable privacy duration time (1 hour up to 24 hours or manual).

Accessories



67931 Desktop kit

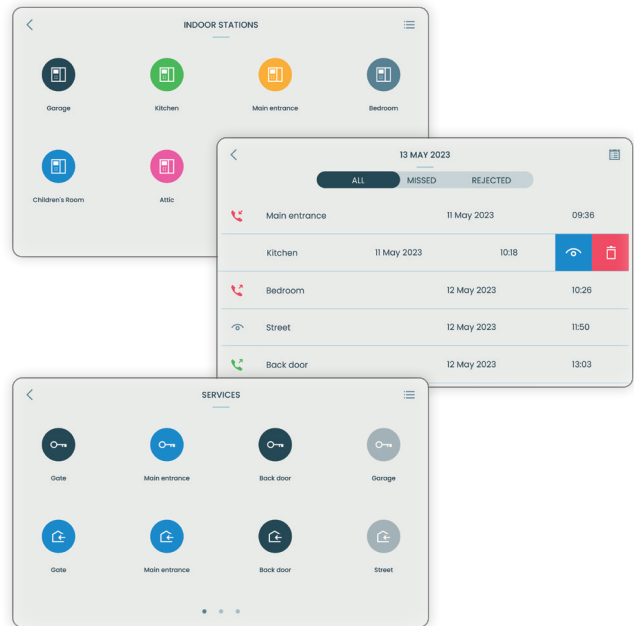
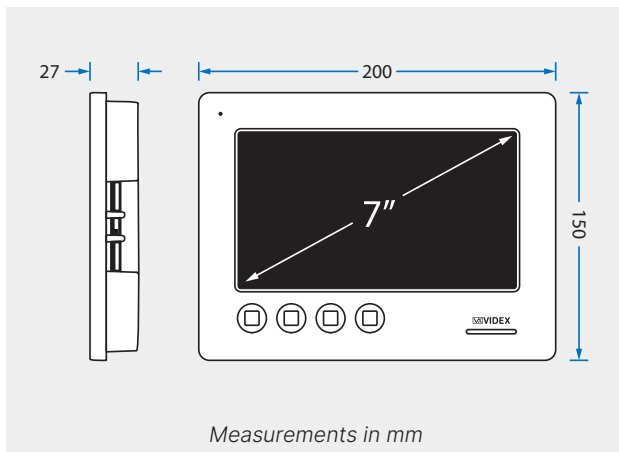

Thermostat Feature

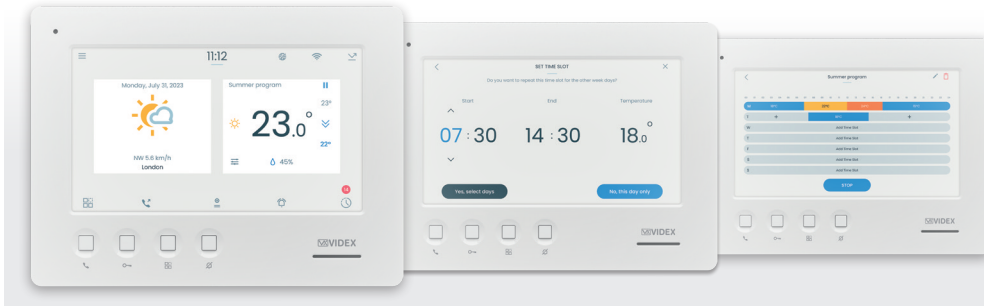

Incorporates a weather location feature and a high quality thermostat and humidity feature with a smart scheduling function.

Technical characteristics

Display/Screen resolution	7" Hi-Res colour LCD TFT capacitive touch screen - 800x480 pixel.	
Handset/Handsfree	Handsfree only (full-duplex handsfree speech).	
Audio annunciation language	Italian or English.	
Video & audio call recording	Yes, displays screenshots, video recordings and audio files captured by the device.	
Supported protocols	Supports both RTSP and HTTP protocols.	
Wi-Fi capability	Yes.	
No. of buttons/Services ¹	4 programmable buttons: Service, camera recall, door-open/Intercommunicating call, privacy ON.	
Programming	Through the touch screen OSD menus, via the internal web browser or via PC using the IPure Wizard software.	
Programmable adjustments	Microphone & speaker volume adjustments. Onscreen brightness and contrast controls.	
Other programming features	Service buttons. Privacy duration time. Number of rings. Ringtone selection. Call tone volume. Date & Time settings. Thermostat settings. Weather location app setup. Event log setup.	Intercommunicating call setup. Door panel setup. CCTV (surveillance camera) integration. 3rd party integrations. Onscreen appearance (OSD theme - light/dark). OSD language selection. Device software update facility. Video streaming quality setup. Smart scheduling for the thermostat feature.
Inputs	2 programmable active low inputs.	
Outputs	2 programmable dry contacts (both C/NO - 35Vdc @ 50mA).	
Power consumption	Standby: 400mA, operating: 600mA.	
Working voltage	18Vdc (650mA) and via 2 wire BUS (32Vdc).	
Mounting	Surface (wall) or via desktop kit.	
Finishes	White.	
Desktop kit	67931.	

¹ Some buttons are used for multiple functions.

Videx CloudNected Client

Videx CloudNected Client is a cross-platform application for smartphones and tablets that allows the user to interface with Videx IP products easily.

Register your account in the app and connect Videx IP devices by simply acquiring the device's QR code.

You can receive incoming calls from your door panel wherever you are, without needing to keep the application open.

Call the connected devices and operate gates and doors even when you are away from home.

Note: this application does not replace the use of traditional monitors; the application performances are subject to the energy saving mode of the smartphone and to connectivity.

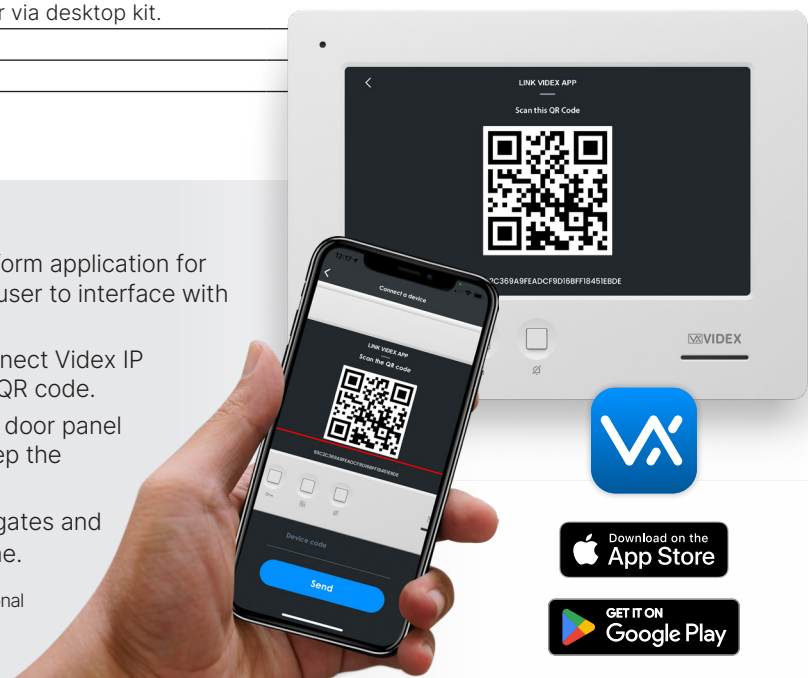

Main UK Office

1 Osprey, Trinity Park, Trinity Way,
London, E4 8TD
tel: 0370 300 1240
www.videxuk.com

Northern UK Office

Unit 4-7 Chillingham Ind. Estate, Chapman Street,
Newcastle Upon Tyne, NE6 2XX
tel: 0370 300 1240
sales@videxuk.com

