

Art. 4837 Speaker unit for "3+1" and "4+1" systems

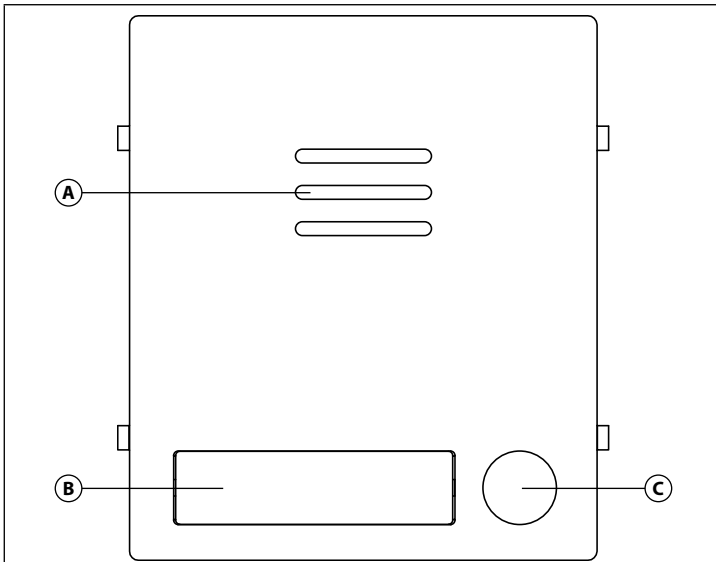

Fig. 1 Front

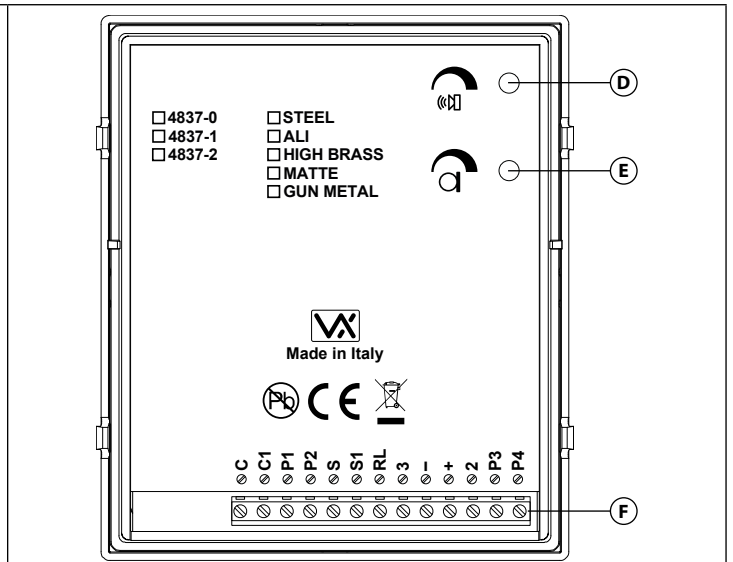

Fig. 2 Back

DESCRIPTION

Speaker unit for "3+1", "4+1" with privacy of speech, intercommunicating audio door entry systems and video door entry systems. The speaker unit circuitry includes:

- The transmitting amplifier with condenser microphone and volume control;
- The receiving amplifier and volume control;
- 2 LEDs to illuminate the name plate (except the Art. 4837-0 model);
- The lock release relay to enable the electric lock;
- The modulated tone generator.
- This speaker unit together with a camera module Art. 4830, can be used on video door entry systems.

AVAILABLE VERSIONS AND BUTTONS LAYOUT

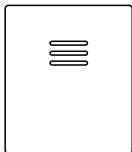

Art. 4837-0

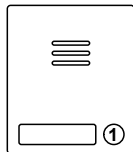

Art. 4837-1

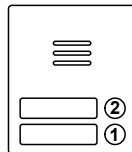

Art. 4837-2

LEGEND

- | | |
|--------------------|------------------------|
| Ⓐ Loudspeaker | Ⓓ Loudspeaker volume |
| Ⓑ Card name holder | Ⓔ Microphone volume |
| Ⓒ Push button | Ⓕ Connection terminals |

CONTROLS

	<p>Loudspeaker volume Adjust the loudspeaker volume. Rotate clockwise to increase or anti-clockwise to decrease</p>
	<p>Microphone volume Adjust the microphone volume. Rotate clockwise to increase or anti-clockwise to decrease</p>

Art. 4837 Speaker unit for "3+1" and "4+1" systems

ADHESIVE GASKET PLACEMENT

Apply the (Y) seal as shown in **Fig. 3**.

ANTI-TAMPERING LOCKS FIXING

Fit the anti-tampering locks (W) as shown in **Fig. 4**.

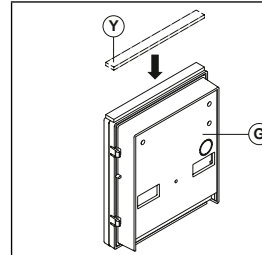
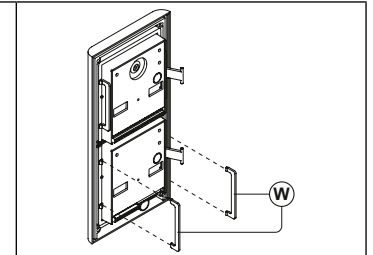
Fig. 3

Fig. 4
HOW TO REMOVE/INSERT THE CARD NAME HOLDER

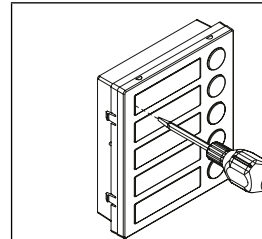
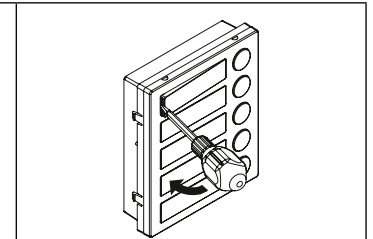
- To avoid damage to the module front plate, mask the side that will be in contact with the screwdriver blade;
- Insert the screwdriver (flat side) into the card-holder hole as shown in **Fig. 5**;
- Move the screwdriver to the left as shown in **Fig. 6** to extract the card name holder;
- Edit the card name then replace it inside the holder and refit: insert the holder inside its housing from the left or right side then push the other side until it clips into place.

Fig. 5

Fig. 6
CONNECTION TERMINALS SIGNALS

C	Push buttons common	
C1	Electronic call tone output (active only on call)	
P1	Output call button 1 (available on all versions except Art. 4837-0)	
P2	Output call button 2 (available only on Art. 4837-2)	
S	Normally open relay contacts (the contact between S and S1 is closed when the unit receives the "door open" signal)	MAX 24Vac/dc 2A
S1		
RL	Active low input to enable the "door open" relay. It can be used for a "push to exit" button or generally to command the "door open" relay	
-	Ground	
1	Speech input	
	"Door Open" signal	
+	12Vdc power input for speaker unit and LED power supply	
2	Speech output	
P3	Output call button 3 (not used)	
P4	Output call button 4 (not used)	

TECHNICAL SPECIFICATION

Power Supply:	+12Vdc
Power Consumption:	Stand-by: Approx. 25mA
	During a call: Approx. 150mA
	During a conversation: Approx. 70mA
Working Temperature:	-20 +60 °C

CLEANING OF THE PLATE

Use a clean and soft cloth. Use moderate warm water or non-aggressive cleansers.

Do not use:

- abrasive liquids;
- chlorine-based liquids;
- metal cleaning products.

Art. 4837 Portiere elettrico per sistemi citofonici "3+1", "4+1"

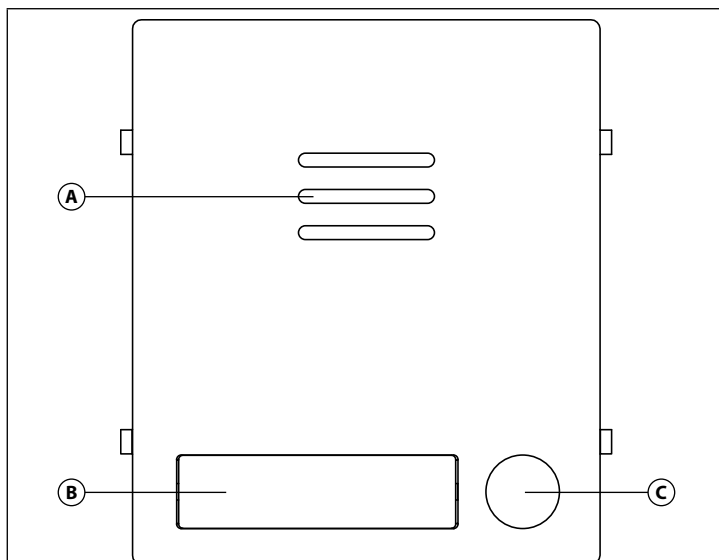

Fig. 1 Fronte

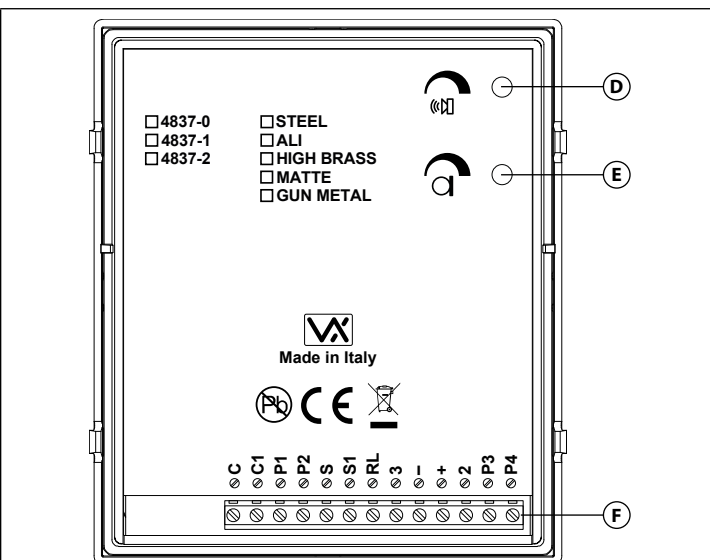

Fig. 2 Retro

DESCRIZIONE

Portiere elettrico per sistemi citofonici "3+1", "4+1" con segreto di conversazione, intercomunicanti e videocitofonici.

La sua elettronica comprende:

- L'amplificatore di trasmissione con microfono a condensatore e regolazione del volume;
- L'amplificatore di ricezione con altoparlante da 0,5W e regolazione del volume;
- 2 LED d'illuminazione cartellini (escluso l' Art. 4837-0);
- Il relè d'asservimento per l'attivazione della serratura elettrica;
- Il circuito di generazione della nota elettronica.

In abbinamento al modulo telecamera Art. 4830, l' Art. 4837 può essere utilizzato anche in impianti videocitofonici.

VERSIONI DISPONIBILI E ORDINE PULSANTI

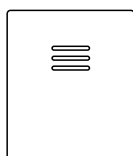

Art. 4837-0

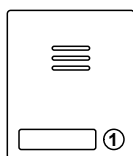

Art. 4837-1

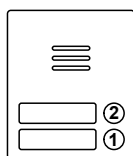

Art. 4837-2

LEGENDA

- | | |
|--------------------------|--------------------------------|
| (A) Altoparlante | (D) Volume altoparlante |
| (B) Porta cartellino | (E) Volume microfono |
| (C) Pulsante di chiamata | (F) Morsetteria di connessione |

REGOLAZIONI



Volume altoparlante

Regolazione del volume dell'altoparlante.
Ruotare in senso orario per aumentare o antiorario per diminuire



Volume microfono

Regolazione del volume del microfono.
Ruotare in senso orario per aumentare o antiorario per diminuire

Art. 4837 Portiere elettrico per sistemi citofonici "3+1", "4+1"

APPLICAZIONE GUARNIZIONE ADESIVA

Applicare la guarnizione adesiva (Y) come mostrato in Fig. 3.

INSERIMENTO FERMI ANTI-EFFRAZIONE

Inserire i fermi anti-effrazione (W) come mostrato in Fig. 4.

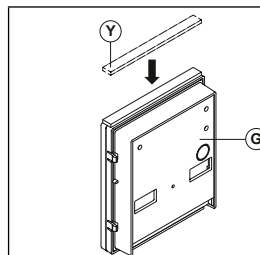

Fig. 3

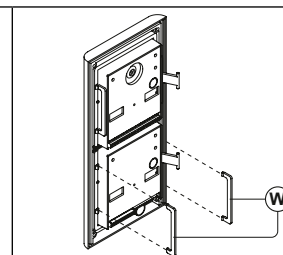

Fig. 4

RIMOZIONE/INSERIMENTO DEL PORTA-CARTELLINO

- Per evitare ammaccature della placca frontale, proteggere il lato che verrà in contatto con la lama del cacciavite utilizzando una striscia di nastro isolante;
- Inserire il cacciavite (lato piatto della lama) nell'apposita fessura del porta cartellino come mostrato in Fig. 5;
- Fare leva con il cacciavite come mostrato in Fig. 6 per rimuovere il porta-cartellino (fare attenzione a non ammaccare la placca);
- Modificare il cartellino e riporlo all'interno del porta-cartellino quindi riposizionare lo stesso al suo posto inserendolo nel suo alloggiamento dal lato destro o sinistro e premendo il lato rimasto libero fino all'aggancio (compiendo un movimento contrario a quello fatto per estrarlo).

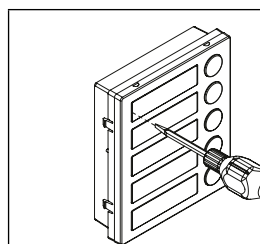

Fig. 5

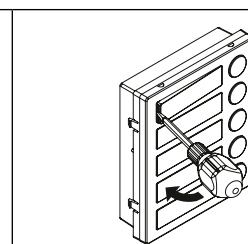

Fig. 6

SEGNALI MORSETTERIA DI CONNESSIONE

C	Comune pulsanti	
C1	Uscita nota elettronica (attiva durante la chiamata)	
P1	Uscita pulsante 1 (disponibile in tutte le versioni eccetto Art. 4837-0)	
P2	Uscita pulsante 2 (disponibile solo per l'Art. 4837-2)	
S	Contatti relé normalmente aperto (il contatto tra S e S1 si chiude al ricevimento del comando "apri-porta")	MAX 24Vac/dc 2A
S1		
RL	Ingresso attivo basso per l'attivazione del relé "apri-porta". Può essere utilizzato per il collegamento di un pulsante "apri-porta" locale o per comandare il relé in genere.	
-	Massa	
1	Ingresso fonia Comando "apri-porta"	
+	Ingresso 12Vdc per alimentazione posto esterno e LED	
2	Uscita fonia	
P3	Uscita pulsante 3 (non in uso)	
P4	Uscita pulsante 4 (non in uso)	

SPECIFICHE TECNICHE

Tensione d'alimentazione: +12Vdc

Assorbimento: Stand-by: Circa 25mA

Durante la chiamata: Circa 150mA

Durante la conversazione: Circa 70mA

Temperatura di lavoro: -20 +60 °C

PULIZIA DELLA PLACCA

Usare un panno morbido e pulito. Usare acqua tiepida o un detergente non aggressivo.

Non usare:

- prodotti abrasivi;
- prodotti contenenti cloro;
- prodotti per la pulizia dei metalli.

3 1 2 12V

ART.3111

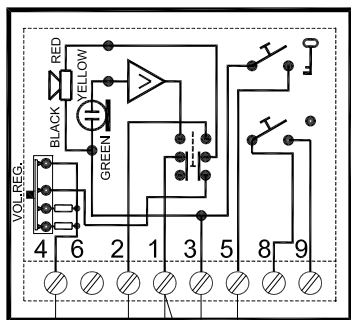

2

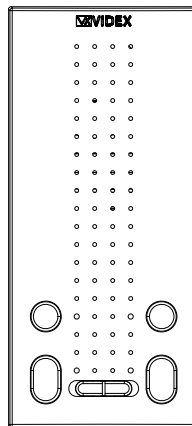

ART.5118

3

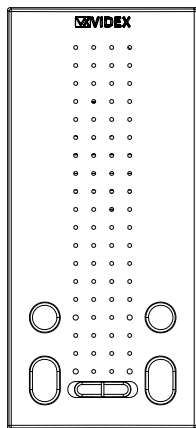
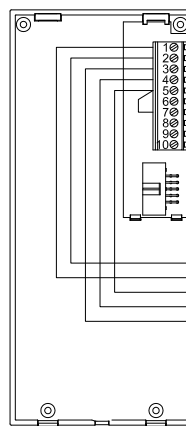

ART.5112

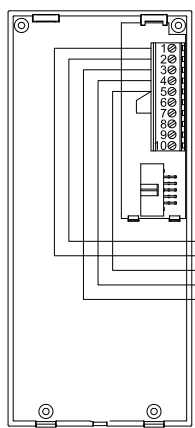

1

Correspondence Table

5112 Terminals	3111
1= 2A	2
2= 4A	4
3= +12Vin	
4= 3A	3
5= 1A	1
6= Two Dot button	
7= 5A	5
8= Dot button	
9= Door Led positive in	
10= Door Led ground in	

Correspondence Table

5118 Terminals	3111
1= 2A	2
2= 4A	4
3= +12Vin	
4= 3A	3
5= 1A	1
6= Local Bell	
7= 5A	5
8= Dot button	
9= Aux Led + 12Vdc	
10= Door Led + 12Vdc	

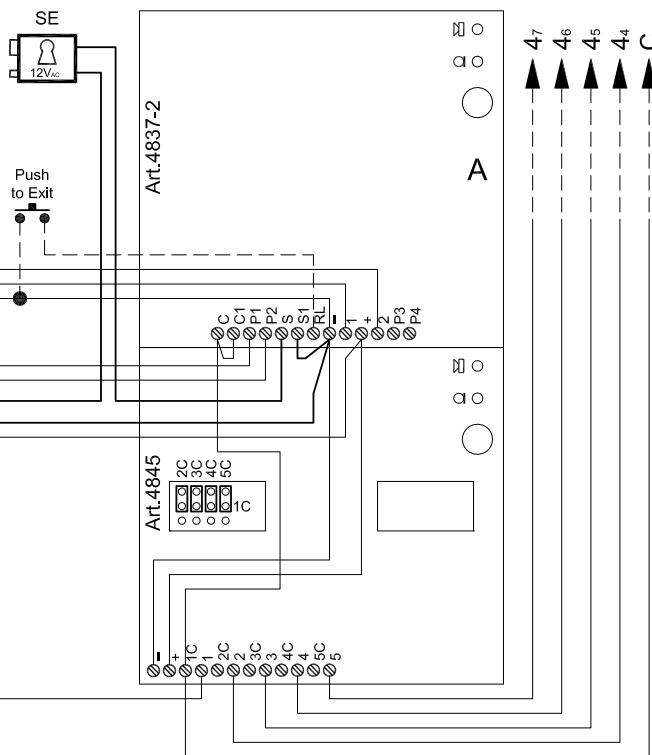

ART.520M

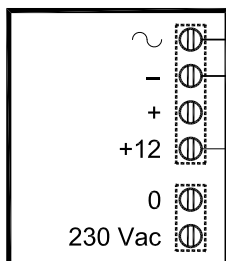

Titolo: "3+1" Audio Door entry system, "n" users", one entrance

Impianto citofonico sistema "3+1", "n" utenti, 1 Ingresso

Videx Electronics S.p.A.
Via del Lavoro 1, 63846 Monte Giberto (FM)
Phone: +39 0734 631669 - Fax: +39 0734 631669
www.videx.it - info@videx.it

Notes:

Notes:

Data creazione:

05/05/2015

Data modifica:

05/05/2015

Autore:

Roberto Gambini

Cod.File:

4kau001g.dwg

Foglio

1 / 1

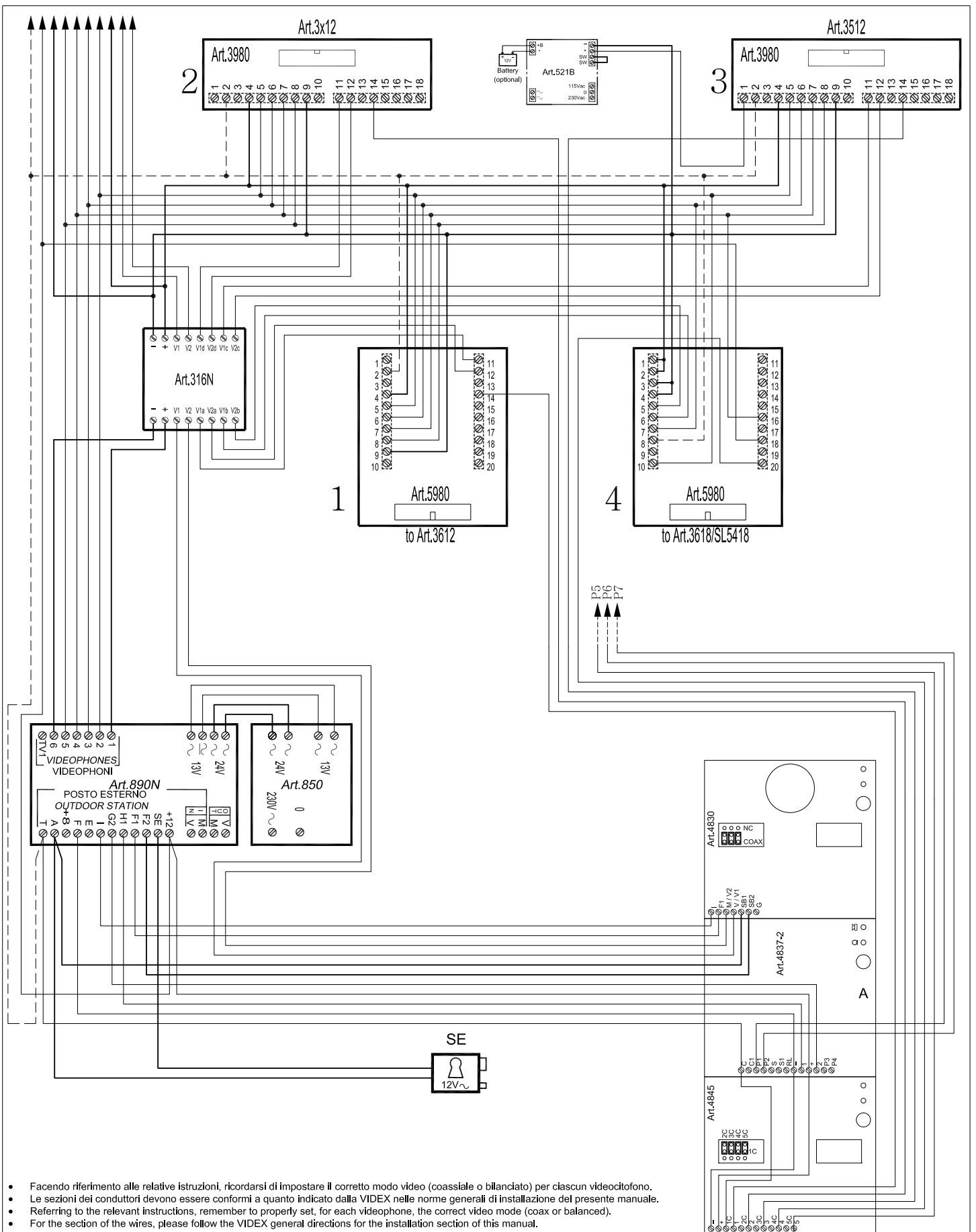

- Facendo riferimento alle relative istruzioni, ricordarsi di impostare il corretto modo video (coassiale o bilanciato) per ciascun videocitofono.
- Le sezioni dei conduttori devono essere conformi a quanto indicato dalla VIDEX nelle norme generali di installazione del presente manuale.
- Referring to the relevant instructions, remember to properly set, for each videophone, the correct video mode (coax or balanced).
- For the section of the wires, please follow the VIDEX general directions for the installation section of this manual.

Title:		Data creazione:	05/05/2015	Foglio	1 / 1
Titolo:		Data modifica:	05/05/2015		
		Autore:	Roberto Gambini		
		Cod. File:	4kvd044.dwg		

Videx Electronics S.p.A.
 Via del Lavoro 1, 63846 Monte Giberto (FM)
 Phone: +39 0734 631669 - Fax: +39 0734 631669
 www.videx.it - info@videx.it

Notes:

Notes:

ENG DISPOSAL

In accordance with the Legislative Decree no. 49 of 14 March 2014 "Implementation of the Directive 2012/19/EU on waste electrical and electronic equipment (WEEE)".

The crossed-out bin symbol on the equipment or on the packaging indicates that when the product reaches the end of its lifetime, it must be collected separately from mixed municipal waste. The user must, therefore, dispose of the equipment at the end of its lifetime in the suitable waste collection centres or bring it to the retailer during the purchase of a new equipment of equivalent type at the ratio of one-to-one. Furthermore, the user is allowed to dispose of the WEEEs of very small size (domestic appliances without any external dimension exceeding 25 cm (9.84 inches) for free to the retailers, without any purchase obligation. The correct waste disposal of the WEEEs contributes to their reuse, recycling and recovery and avoids potential negative effects on the environment and human health due to the possible presence of dangerous substances within them.



ITA SMALTIMENTO

Ai sensi del Decreto Legislativo 14 marzo 2014, n° 49 "Attuazione della direttiva 2012/19/UE sui rifiuti di apparecchiature elettriche ed elettroniche (RAEE)".

Il simbolo del cassonetto barrato riportato sull'apparecchiatura o sulla sua confezione indica che il prodotto alla fine della propria vita utile deve essere raccolto separatamente dagli altri rifiuti urbani misti. L'utente dovrà, pertanto, conferire l'apparecchiatura giunta a fine vita presso gli idonei centri di raccolta differenziata oppure riconsegnarla al rivenditore al momento dell'acquisto di una nuova apparecchiatura di tipo equivalente, in ragione di uno a uno. L'utente ha, inoltre, la possibilità di conferire gratuitamente presso i distributori, senza alcun obbligo di acquisto, per i RAEE di piccolissime dimensioni (per le apparecchiature di tipo domestico con nessuna dimensione esterna superiore a 25 cm).

L'adeguata raccolta differenziata dei RAEE contribuisce al loro riutilizzo, riciclaggio e recupero ed evita potenziali effetti negativi sull'ambiente e sulla salute umana dovuti alla eventuale presenza di sostanze pericolose al loro interno.

FRA ÉLIMINATION

Conformément au décret législatif n° 49 du 14 mars 2014 relatif à l'« Application de la directive 2012/19 / UE relative aux déchets d'équipements électriques et électroniques (DEEE) ».

Le symbole de la poubelle barrée sur l'équipement ou sur son emballage indique que le produit en fin de vie utile doit être collecté séparément des autres déchets municipaux en mélange. L'utilisateur doit donc remettre l'équipement en fin de vie aux centres de collecte appropriés ou le restituer au revendeur lors de l'achat d'un nouveau type d'équipement équivalent, dans le rapport de un à un. De plus, l'utilisateur a la possibilité de conférer gratuitement aux distributeurs, sans aucune obligation d'achat, de très petits DEEE (pour les appareils ménagers sans dimensions extérieures supérieures à 25 cm). La collecte séparée adéquate des DEEE contribue à leur réutilisation, leur recyclage et leur valorisation et évite les éventuels effets négatifs sur l'environnement et la santé humaine en raison de la présence possible de substances dangereuses dans ceux-ci.

SPA ELIMINACIÓN

De conformidad con el Decreto legislativo n. 49 de 14 de marzo 2014 "Aplicación de la Directiva 2012/19/UE relativa a residuos de aparatos eléctricos y electrónicos (RAEE)".

El símbolo del contenedor tachado indicado sobre los aparatos o sobre los embalajes señala que el producto al final de su vida útil debe ser recogido separadamente de otros residuos municipales mezclados. Por tanto, el usuario deberá conferir los aparatos al final de su vida útil en los apropiados centros de recogida selectiva o devolverlos al revendedor al momento de la compra de nuevos aparatos equivalentes, en una relación de uno a uno. Además, el usuario tiene la posibilidad de entregar sin cargo a los distribuidores, sin ninguna obligación de compra, los RAEEs muy pequeños (para electrodomésticos sin dimensiones externas superiores a 25 cm).

La recogida selectiva apropiada de los RAEEs contribuye a su reutilización, reciclaje y valorización y evita potenciales impactos negativos sobre el medio ambiente y la salud humana debidos a la posible presencia de sustancias peligrosas dentro de ellos.

NLD VERWIJDERING

In overeenstemming met het Wetsbesluit nr. 49 van 14 maart 2015 "Implementatie van de Richtlijn 2012/19/EU inzake afgedankte elektrische en elektronische apparaten (AEEA)".

Het doorgekruiste vuilnisbaksymbool op het apparaat of de verpakking geeft aan dat het product aan het einde van zijn levensduur niet samen met het gewone huisvuil weggegooid mag worden. De gebruiker moet het apparaat aan het einde van zijn levensduur inleveren bij een gepast inzamelpunt of de winkel waar hij een nieuw apparaat van een gelijksoortig type zal kopen. De gebruiker kan tevens AEEA's van een zeer klein formaat (huishoudapparaten met een buitenafmeting kleiner dan 25 cm (9,84 inch) gratis en zonder enige aankoopverplichting bij handelaars inleveren. Een juiste verwijdering van AEEA's draagt bij tot hergebruik, recycling en terugwinning, en voorkomt potentiële negatieve effecten op het milieu en de menselijke gezondheid door de mogelijke aanwezigheid van gevaarlijke stoffen.

POR ELIMINAÇÃO

De acordo com o Decreto Legislativo n.º 49 de 14 de março de 2014 "Implementação da Diretiva 2012/19/UE relativa aos resíduos de equipamentos elétricos e eletrónicos (REEE)".

O símbolo do caixote do lixo riscado no equipamento ou na embalagem indica que quando o produto atinge o fim da sua vida útil, deve ser recolhido separadamente dos resíduos urbanos mistos. O utilizador deve, portanto, eliminar o equipamento no final da sua vida útil nos centros de recolha de resíduos adequados ou levá-lo ao vendedor durante a compra de um novo equipamento de tipo equivalente, na proporção de um para um. Além disso, o utilizador pode eliminar gratuitamente os REEE de dimensões muito reduzidas aos vendedores, sem qualquer obrigação de compra. (só aparelhos domésticos sem qualquer dimensão externa que exceda 25 cm, ou seja 9,84 polegadas). A correta eliminação dos REEE contribui para a sua reutilização, reciclagem e recuperação e evita potenciais efeitos negativos sobre o ambiente e a saúde humana devido à possível presença de substâncias perigosas no seu interior.

MANUFACTURER FABBRICANTE FABRICANT FABRICANTE FABRIKANT FABRICANTE الشركة المصنعة	VIDEX ELECTRONICS S.P.A. Via del Lavoro, 1 63846 Monte Giberto (FM) Italy Tel (+39) 0734 631669 Fax (+39) 0734 632475 www.videx.it - info@videx.it	
CUSTOMER SUPPORT SUPPORTO CLIENTI SUPPORTS CLIENTS ATENCIÓN AL CLIENTE KLANTENDIENST APOIO AO CLIENTE خدمة العملاء	VIDEX ELECTRONICS S.P.A. www.videx.it - technical@videx.it Tel: +39 0734-631669 Fax: +39 0734-632475	UK Customers only: VIDEX SECURITY LTD www.videxuk.com Tech Line: 0191 224 3174 Fax: 0191 224 1559

Main UK office:
VIDEX SECURITY LTD
 1 Osprey Trinity Park
 Trinity Way
 LONDON E4 8TD
 Phone: (+44) 0370 300 1240
 Fax: (+44) 020 8523 5825
 www.videxuk.com
 marketing@videxuk.com

Greece office:
VIDEX HELLAS Electronics
 48 Filolaou Str.
 11633 ATHENS
 Phone: (+30) 210 7521028
 (+30) 210 7521998
 Fax: (+30) 210 7560712
 www.videx.gr
 videx@videx.gr

Benelux office:
NESTOR COMPANY NV
 E3 laan, 93
 B-9800 Deinze
 Phone: (+32) 9 380 40 20
 Fax: (+32) 9 380 40 25
 www.videx.be
 info@videx.be

Northern UK office:
VIDEX SECURITY LTD
 Unit 4-7
 Chillingham Industrial Estate
 Chapman Street
 NEWCASTLE UPON TYNE - NE6 2XX
 Tech Line: (+44) 0191 224 3174
 Phone: (+44) 0370 300 1240
 Fax: (+44) 0191 224 1559

Danish office:
VIDEX DANMARK
 Hammershusgade 15
 DK-2100 COPENHAGEN
 Phone: (+45) 39 29 80 00
 Fax: (+45) 39 27 77 75
 www.videx.dk
 videx@videx.dk

Dutch office:
NESTOR COMPANY BV
 Business Center Twente (BCT)
 Grotestraat, 64
 NL-7622 GM Borne
 www.videxintercom.nl
 info@videxintercom.nl



The product is CE marked demonstrating its conformity and is for distribution within all member states of the EU with no restrictions. This product follows the provisions of the European Directives 2014/30/EU (EMC); 2014/35/EU (LVD); 2011/65/EU (RoHS); CE marking 93/68/EEC.

Le produit est marqué CE à preuve de sa conformité et peut être distribué librement à l'intérieur des pays membres de l'union européenne UE.
 Ce produit est conforme aux directives européennes 2014/30/EU (EMC) ; 2014/35/EU (LVD) ; 2011/65/EU (RoHS) : marquage CE 93/68/EEC.

Het product heeft de CE-markering om de conformiteit ervan aan te tonen en is bestemd voor distributie binnen de lidstaten van de EU zonder beperkingen. Dit product volgt de bepalingen van de Europese Richtlijnen 2014/30/EU (EMC); 2014/35/EU (LVD); 2011/65/EU (RoHS); CE-markering 93/68/EEC.

يحمل المنتج علامة التوافق الأوروبي CE لإظهار توافقه مع المواصفات ذات الصلة وإمكانية توزيعه في كافة دول الاتحاد الأوروبي بدون أية قيود. يلبي هذا المنتج جميع متطلبات التوجيهات الأوروبية 2014/30/UE (EMC) ; 2014/35/UE (LVD) ; 2011/65/UE (RoHS) : علامة المطابقة للمواصفات الأوروبية 93/68/EEC.

Il prodotto è marchiato CE a dimostrazione della sua conformità e può essere distribuito liberamente all'interno dei paesi membri dell'Unione Europea UE.
 Questo prodotto è conforme alle direttive Europee: 2014/30/UE (EMC); 2014/35/UE (LVD); 2011/65/UE (RoHS); marcatura CE 93/68/EEC.

El producto lleva la marca CE que demuestra su conformidad y puede ser distribuido en todos los estados miembros de la unión europea UE.
 Este producto cumple con las Directivas Europeas 2014/30/EU (EMC); 2014/35/EU (LVD); 2011/65/EU (RoHS); marca CE 93/68/EEC.

O produto tem a marca CE que demonstra a sua conformidade e destina-se a distribuição em todos os estados membros da UE, sem restrições. Este produto segue as disposições das Diretivas Europeias 2014/30/UE (EMC); 2014/35/UE (LVD); 2011/65/UE (RoHS); marcação CE 93/68/EEC.

