

VIDEOKIT

VK8K/6458 SERIES

"6 Wire" bus one way, two way videokit

VK8K

VK8KC

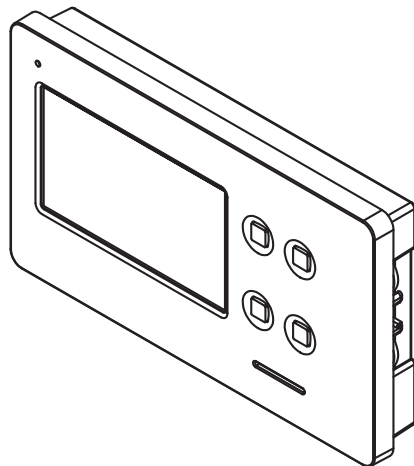
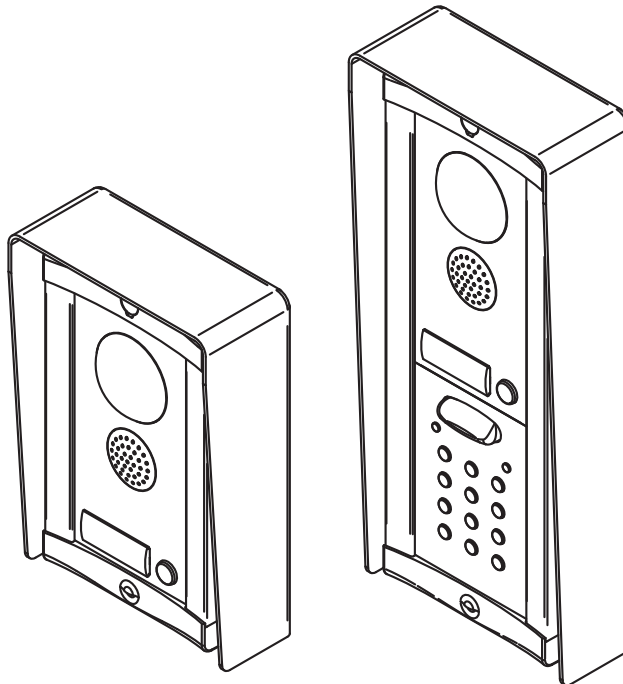

6458

Installation handbook



Index

Introduction	2
System components and available versions	3
General directions for installation	5
Troubleshooting guide	6
Art. 8833 Speaker unit	7
Art. 8800 - Art. 8800-3 Digital codelock module	10
8000 Series Surface and flush mounting door station installation.....	13
Art. 6458 4.3" hands free colour display digital videophone	15
6400 Series Videophone wall mounting instructions	18
Art. 316 - Art. 316N 4 Way video distributor for system with balanced video signal ("4+1").....	19
Installation diagrams	20

NOTES AND SUGGESTIONS

- All diagrams refer to all kits versions: flush or surface, colour or black & white.
- Dashed connections refer to optional connections ("Local bell", "Push to exit" & "Door monitor").
- Some diagrams show how to connect a 12Vdc electric lock: these directions are suitable for all diagrams in this manual.
- Each time a setting is changed on a videophone (address, extension, number of rings etc.), the videophone must be disconnected from the relevant connection board then after a few seconds reconnected again to allow the recognizing of the new setting.
- All diagrams shown are valid for B&W or colour systems with surface or flush mount door station.

DECLARATION OF RESPONSIBILITY

This manual has been written and revised carefully. The instructions and the descriptions which are included in it are referred to VIDEX parts and are correct at the time of print. However, subsequent VIDEX parts and manuals, can be subject to changes without notice. VIDEX Electronics S.p.A. cannot be held responsible for damages caused directly or indirectly by errors, omissions or discrepancies between the VIDEX parts and the Manual.



WE RECOMMEND

This equipment is installed by a Competent Electrician, Security on Communications Engineer

System components and available versions

VK8K/6458 Colour videokit.

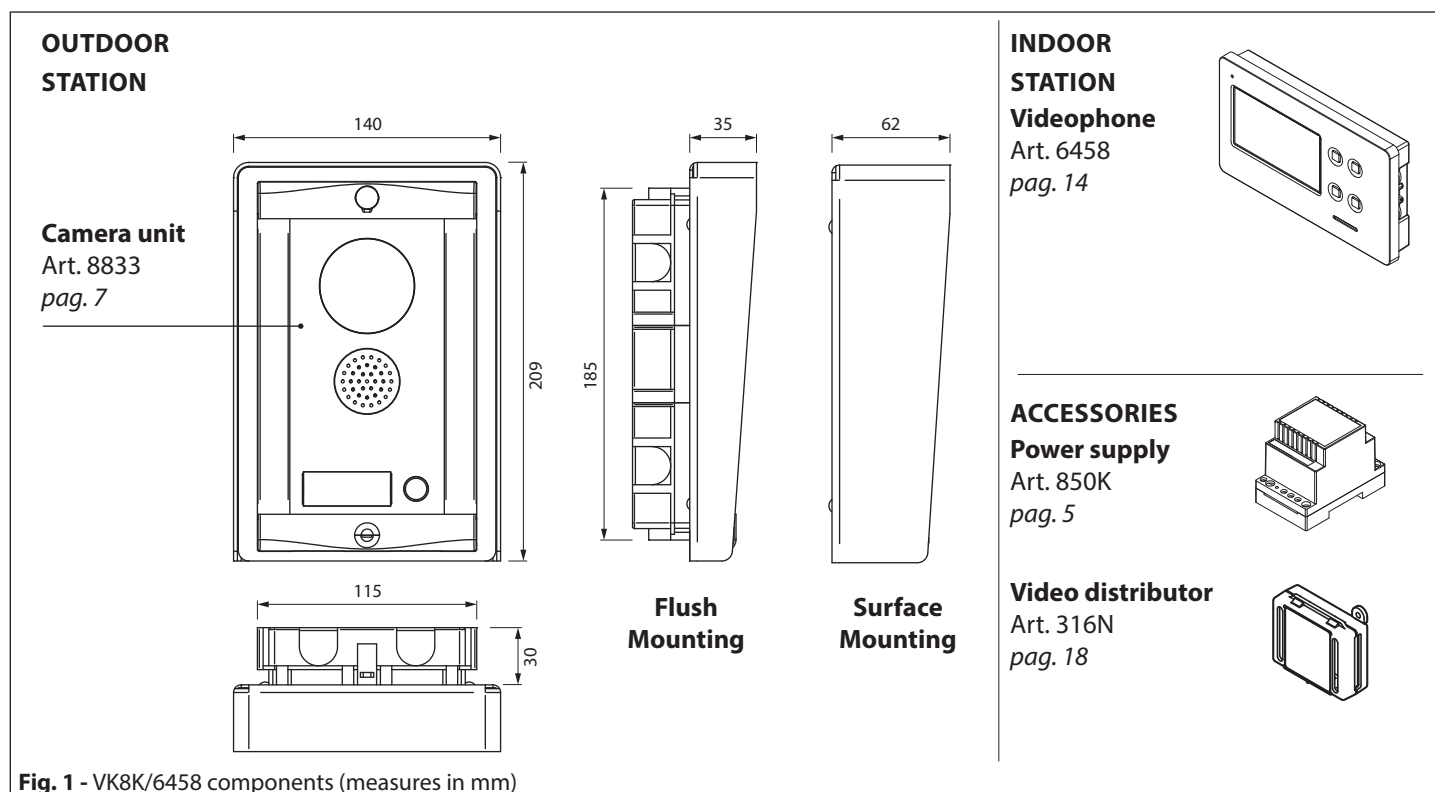

Fig. 1 - VK8K/6458 components (measures in mm)

	VK8K-1/6458 - flush mounting	VK8K-1S/6458 - surface mounting	VK8K-2/6458 - flush mounting	VK8K-2S/6458 - surface mounting
ONE WAY VERSIONS	1 Outdoor station composed of: 1 Art. 8833-1: 1 button camera unit 1 Art. 8855: Flush mounting box 1 Art. 8875: Rainshield	1 Colour videophone Art. 6458	1 Power supply Art. 850K	
	1 Outdoor station composed of: 1 Art. 8833-1: 1 button camera unit 1 Art. 8885: Surface mounting box	1 Colour videophone Art. 6458	1 Power supply Art. 850K	
TWO WAY VERSIONS	1 Outdoor station composed of: 1 Art. 8833-2: 2 buttons camera unit 1 Art. 8855: Flush mounting box 1 Art. 8875: Rainshield	2 Colour videophones Art. 6458	2 Power supplies Art. 850K	1 Video distributor Art. 316N
	1 Outdoor station composed of: 1 Art. 8833-2: 2 buttons camera unit 1 Art. 8885: Surface mounting box	2 Colour videophones Art. 6458	2 Power supplies Art. 850K	1 Video distributor Art. 316N

VK8KC/6458 Colour videokit plus a codelock module.

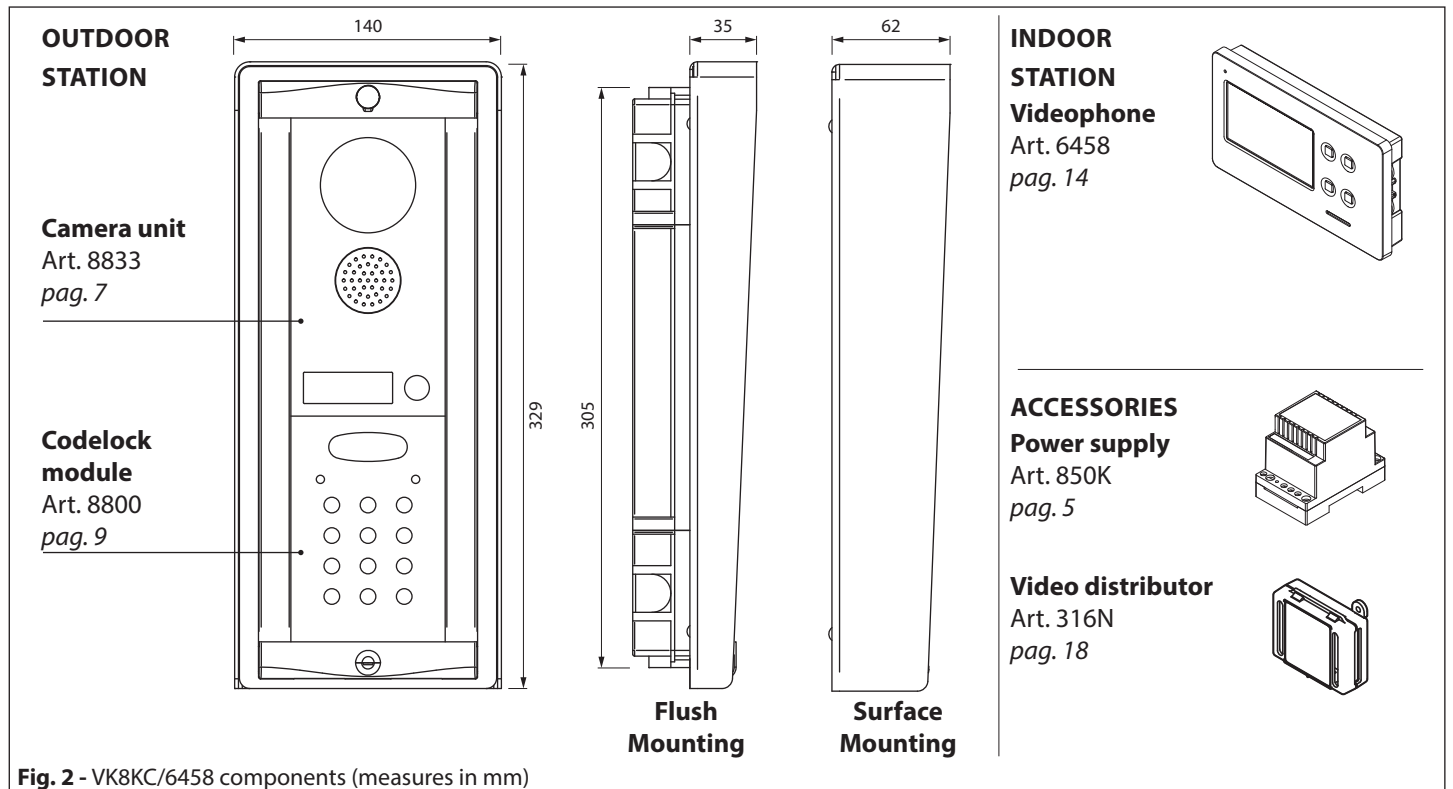

Fig. 2 - VK8KC/6458 components (measures in mm)

ONE WAY VERSIONS	VK8KC-1/6458 - flush mounting	1 Outdoor station composed of: 1 Art. 8833-1: 1 button camera unit 1 Art. 8800: Codelock module 1 Art. 8857: Flush mounting box 1 Art. 8877: Rainshield	1 Colour videophone Art. 6458	1 Power supply Art. 850K
	VK8KC-1S/6458 - surface mounting	1 Outdoor station composed of: 1 Art. 8833-1: 1 button camera unit 1 Art. 8800: Codelock module 1 Art. 8887: Surface mounting box	1 Colour videophone Art. 6458	1 Power supply Art. 850K
TWO WAY VERSIONS	VK8KC-2/6458 - flush mounting	1 Outdoor station composed of: 1 Art. 8833-2: 2 buttons camera unit 1 Art. 8800: Codelock module 1 Art. 8857: Flush mounting box 1 Art. 8877: Rainshield	2 Colour videophones Art. 6458	2 Power supplies Art. 850K 1 Video distributor Art. 316N
	VK8KC-2S/6458 - surface mounting	1 Outdoor station composed of: 1 Art. 8833-2: 2 buttons camera unit 1 Art. 8800: Codelock module 1 Art. 8887: Surface mounting box	2 Colour videophones Art. 6458	2 Power supplies Art. 850K 1 Video distributor Art. 316N

General directions for installation

CONNECTION TO MAINS

The system must be installed according to national rules in force, in particular we recommend to:

- Connect the system to the mains through an **all-pole circuit breaker** which shall have contact separation of at least 3mm in each pole and shall disconnect all poles simultaneously;
- The **all-pole circuit breaker** shall be placed for easy access and the switch shall remain readily operable.

POWER SUPPLY INSTALLATION

- Remove the terminal side covers by unscrewing the retaining screws;
- Fix the power supply to a DIN bar or directly to the wall using two expansion type screws;
- Switch off the mains using the circuit breaker mentioned above and then make the connections as shown on the installation diagrams;
- Check the connections and secure the wires into the terminals;
- Replace the terminal covers and fix them using the relevant screws;
- After completing the wiring, double check all connections then restore the mains.

CABLE SIZE

Video connections and Audio connections must be wired in twisted pair: pair the video lines (terminals/signals "V1" and "V2"), pair the audio lines (terminals /signals "1" and "2").

⚠ IMPORTANT NOTE: SOLID COPPER CABLES MUST BE USED. COPPER COATED STEEL (CCS) AND COPPER COATED ALUMINIUM (CCA) CAN NOT BE USED ON THE SYSTEM.

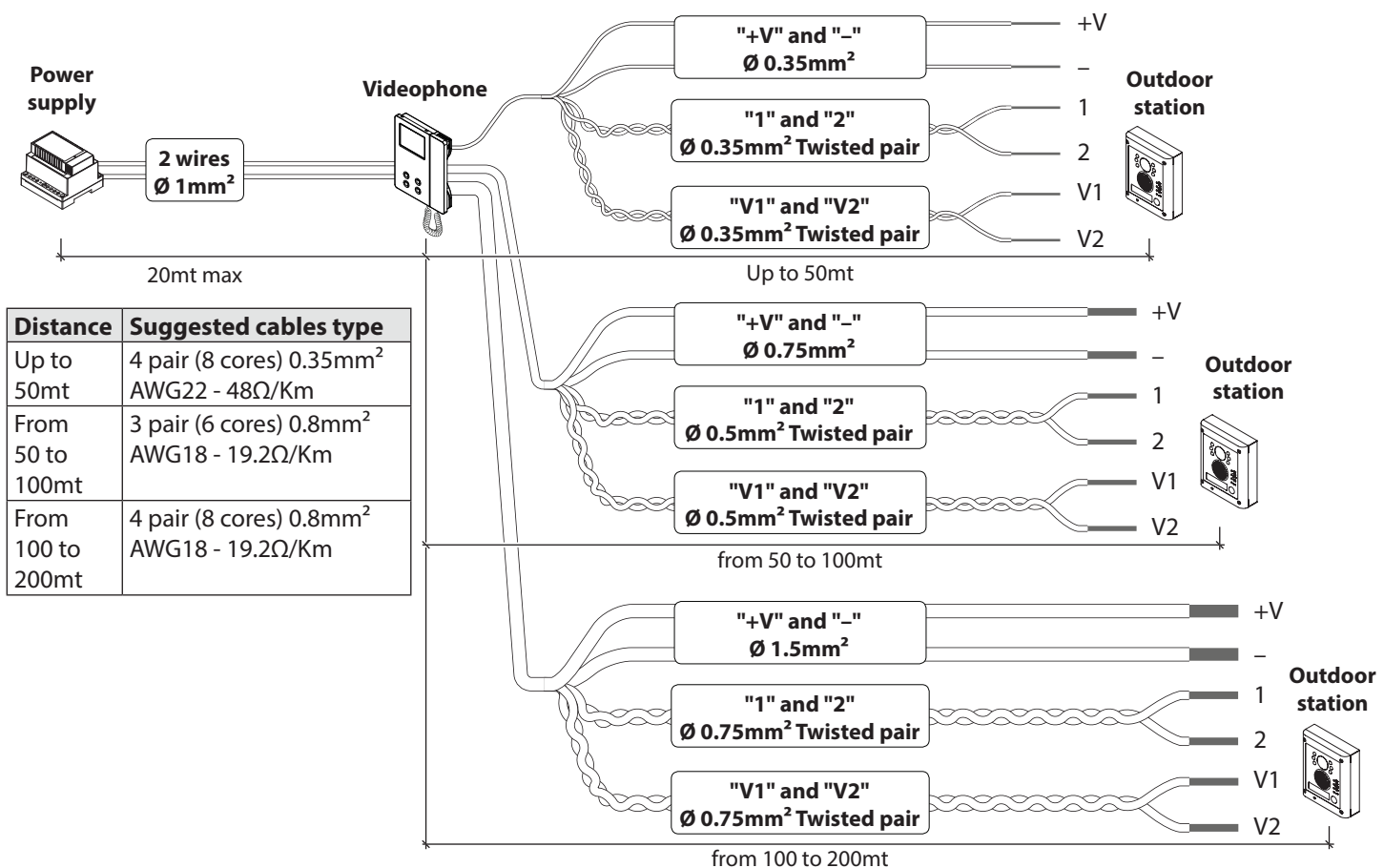
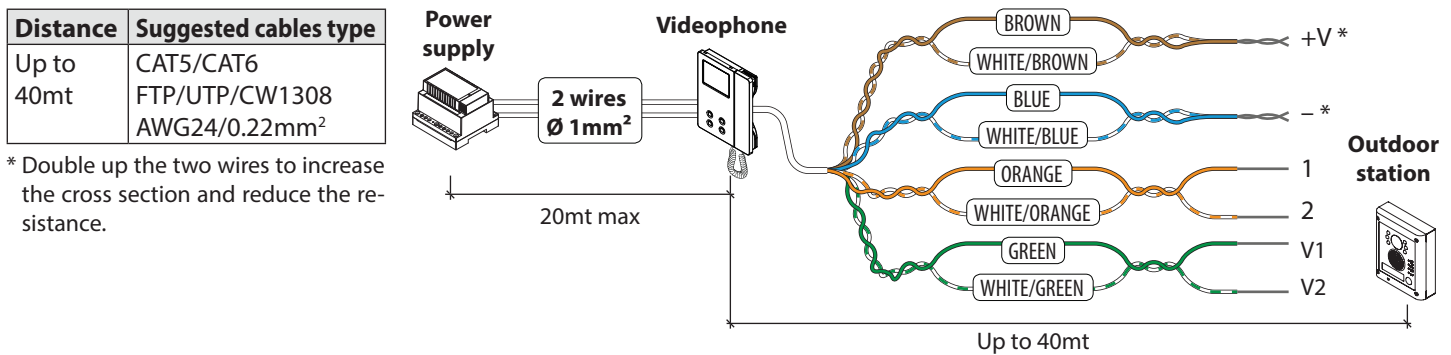

Troubleshooting guide

In case of system failure, try the following preliminary checks:

- Check that the cables are connected as shown in the installation diagram and that the cables are firmly fixed into the relevant terminals;
- Check that the mains voltage is available on terminals 230Vac (or 127Vac) and 0 of the power transformer Art. 850K;
- Check the 24Vac voltage output of the power transformer Art. 850K. If this voltage is not available it could be the 1,6A fuse, in this case remove the mains voltage, remove possible short-circuits or overload sources then replace the fuse with an equal or equivalent one.
- Check that the voltage between the terminals "+" and "-" of the speaker unit is between 16 and 20Vdc.

If the problem persists try the tests in the following table or contact technical support.

SYMPTOM	CAUSE	SOLUTION
The door station is not able to call the extension (the bell LED is switched on for 2 seconds):	<ul style="list-style-type: none"> • Wrong connection between door station and the videophone • Cable size too small. • Programmed videophone address incorrect. • You have changed the videophone address without power down the system. 	<ul style="list-style-type: none"> • Check the 6 common wire connections especially wire "1" (speech line/data). • Increase cable size or double up using two wires for each connection. • Check videophone address on dip-switches. • Power down the system then power up again to detect the new videophone address.
External call works but when answered the communication fails:	<ul style="list-style-type: none"> • Cable size too small. 	<ul style="list-style-type: none"> • Increase cable size or double up using two wires for each signal.
During the conversation it is not possible to open the door:	<ul style="list-style-type: none"> • Cable size too small. 	<ul style="list-style-type: none"> • Increase cable size or double up using two wires for each signal.
During the conversation it is not possible to open the door but the key LED on the door station switches on for the programmed time:	<ul style="list-style-type: none"> • Incorrect position of J2 jumper. • Electric lock wires unconnected or in short. • Wrong electric lock type. 	<ul style="list-style-type: none"> • Check J2 position on the door station. • Check connection. • Check that the electric lock type (ac or dc) is suitable for the J2 position chosen.
Speech only from outside to inside:	<ul style="list-style-type: none"> • Wire "2" broken or in short. 	<ul style="list-style-type: none"> • Check connection of wire "2".
Low volume of speech:	<ul style="list-style-type: none"> • Volume trimmers of door station require adjustment. 	<ul style="list-style-type: none"> • Adjust the trimmers until the required volume is reached.
Noise over the speech line during the conversation:	<ul style="list-style-type: none"> • The 6 common wires are cabled together with 230 or 380Vac power lines. • The 6 common wires are cabled together with 24Vac videophone power supply wires. 	<ul style="list-style-type: none"> • Separate the 6 common wires from the high voltages cables. • Separate the 6 common wires from the two 24Vac wires or cable them together only for a short distance.
Camera recall service does not work:	<ul style="list-style-type: none"> • Camera recall button pressed for a number of times different from the ID of the door station to be switched on. 	<ul style="list-style-type: none"> • Check the ID (1..4) of the door station to be recalled and press the camera recall button as many time as the ID value.
Intercommunicating call does not work:	<ul style="list-style-type: none"> • "Key" button pressed for a number of times different from the videophone address value. 	<ul style="list-style-type: none"> • Check the address of the videophone you are calling and try again.
The video shown on the monitor is of a bad quality and the image is distorted or double	<ul style="list-style-type: none"> • V1,V2 signals unconnected, reversed or shorted. • The switches of the two way dip-switch are not both in ON position. • V1,V2 of the last Art. 316N (if present) not closed with 75 Ohm resistor. 	<ul style="list-style-type: none"> • Check that the wires are not broken or shorted. • Set both switches to the ON position. • Use 2x 75 Ohm resistors to connect V1 & V2 to 0V.
Local call does not work:	<ul style="list-style-type: none"> • Wrong connection or call button broken. 	<ul style="list-style-type: none"> • Check connection or replace the button.

Art. 8833 Speaker unit

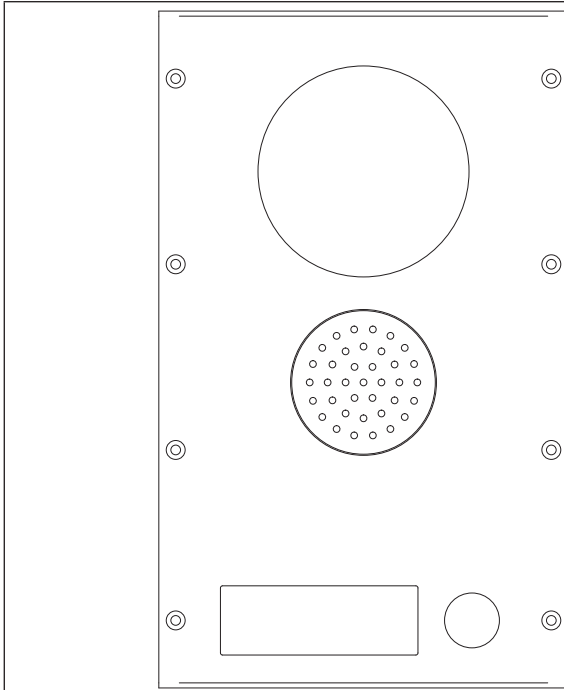

Fig. 1 Front

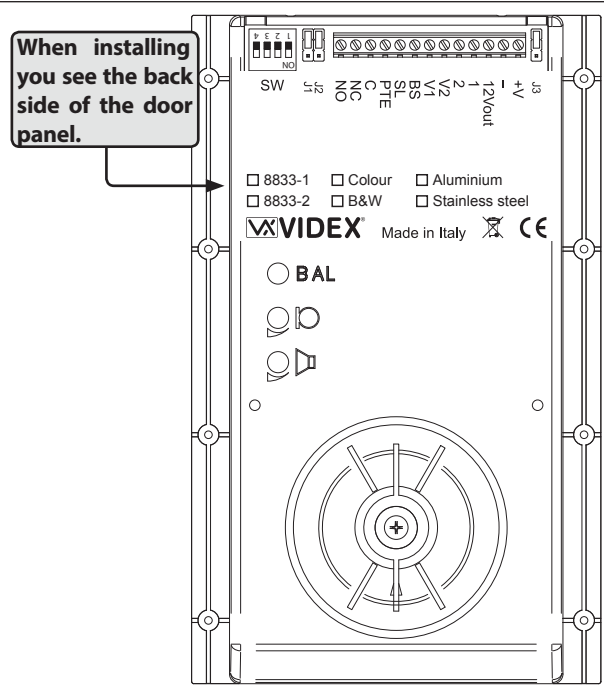

Fig. 2 Back (upside down view)

CONTROLS (SPEAKER & MICROPHONE VOLUME)



Trimmer to adjust the speaker volume. Rotate clockwise to increase or anti-clockwise to decrease.



Trimmer to adjust the microphone volume. Rotate clockwise to increase or anticlockwise to decrease.

SETTINGS (DIP-SWITCH & JUMPERS)

4 WAY DIP-SWITCH

First two switches are used to set the speaker unit address: the speaker unit address is required for camera recall operation on 2 or more entrance systems.

SW	Switches 1,2	Unit Address
	OFF OFF	1
	ON OFF	2
	OFF ON	3
	ON ON	4

SW	Switch 3	Conversation Time
	OFF	60 seconds
	ON	120 seconds

SW	Switch 4	Door opening time (J2 = "L" position)
	OFF	2 seconds
	ON	6 seconds

JUMPERS J1, J2, J3

J1=	Reassurance tone volume = Low
J1=	Reassurance tone volume = High
J2=	Door open relay operating mode = Capacitor discharge
J2=	Door open relay operating mode = Dry Contacts
J3=	Only for Art. 8833-2, call buttons operating mode = each button calls a different videophone
J3=	Only for Art. 8833-2, call buttons operating mode = both buttons call the same videophone

HOW TO REMOVE/INSERT THE CARD NAME HOLDER

- To avoid damage to the module front plate, mask the side that will be in contact with the screwdriver blade;
- Insert the screwdriver (flat side) as shown in Fig. 3;
- Move the screwdriver to the left as shown in Fig. 4 to extract the card name holder;
- Edit the card name then replace it inside the holder and refit: insert the holder inside its housing from the left or right side then push the other side until it clips into place.

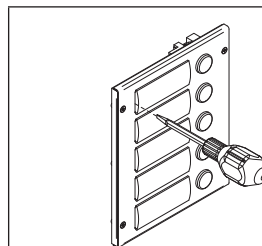

Fig. 3

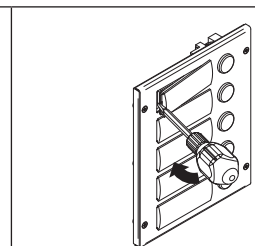

Fig. 4

Art. 8833 Speaker unit

HOW TO CONNECT ELECTRIC LOCK

The "door-open" relay can operate either as "dry contact" or "capacitive discharge" mode.

- In "dry contact" operation mode the relay works in a traditional way, a power supply or a power source is needed to operate the lock (12-24Vac/dc 2A max), and activation lasts according to the door opening time programmed.
- In "capacitive discharge" operation mode the relay's contacts, when active, supply directly the lock (12Vac/dc 1A max) for a moment. You don't need a power supply for the lock and the door opening time programmed do not affect the activation time.

A possible deterioration of the mechanical performance of the electric lock, might cause the "capacitive discharge" malfunctioning in time. In case the electric lock is used in very dusty environments or in peculiar climate conditions, we suggest to use the "open door" relay in "dry contacts" mode.

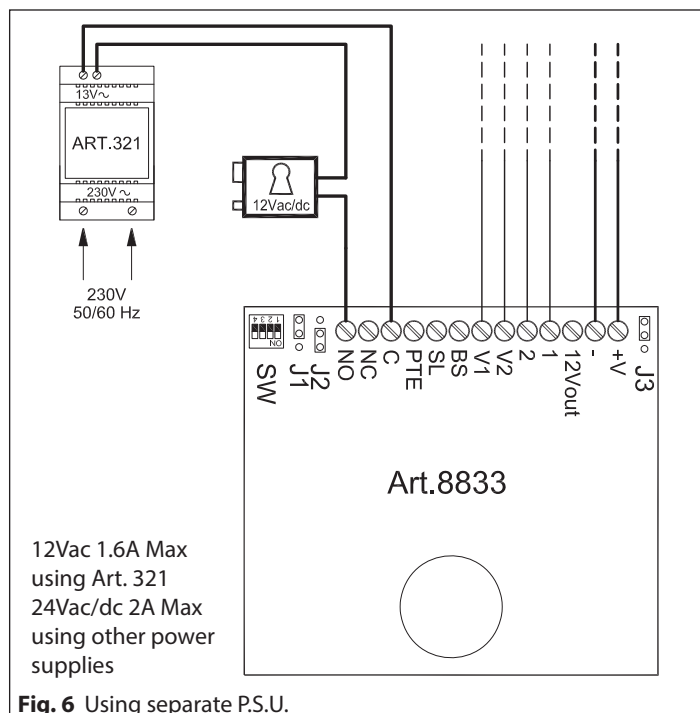
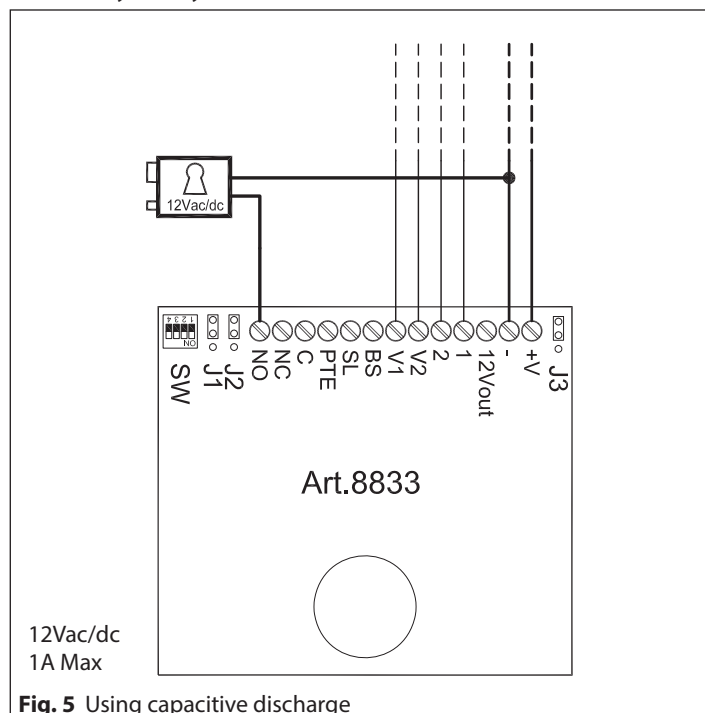
SIGNALS (TERMINALS)

NO	Door open relay normally open contact	Max 24Vdc, 3mA when used as dry contacts relay
NC	Door open relay normally closed contact	
C	Door open relay common contact	
PTE	Active low input to control directly the door open relay	
SL	Active low output to enable the enslavement relay for video signal exchange (active with a call in progress)	
BS	Input/Output busy signal (about 12V in stand-by, about 0V with a call in progress)	
V2	Balanced video signal sync.+	
V1	Balanced video signal sync.-	
2	Speech line output from the microphone (about 12V in stand-by, about 3V with a conversation in progress)	
1	Speech line input toward the loudspeaker and data signal (about 12V in stand-by, about 5V with a conversation in progress)	
12Vout	12Vdc. 0,3A max. output to supply accessories	
-	Power input ground	
+V	Power input 16÷20Vdc	

MAXIMUM ILLUMINATION DISTANCE FROM CAMERA AT NIGHT

The illumination LED's within the camera will illuminate the visitor when they are within 50 cm of the camera.

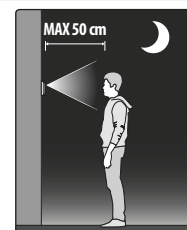
CLEANING OF THE PLATE

Use a clean and soft cloth. Use moderate warm water or non-aggressive cleansers.

Do not use:

- abrasive liquids;
- chlorine-based liquids;
- metal cleaning products.

TECHNICAL SPECIFICATION

Power Supply:	20Vdc
Power consumption:	Stand-by: 70mA Operating: 250mA
Working Temperature:	-10 +50 °C

Art. 8800 - Art. 8800-3 Digital codelock module

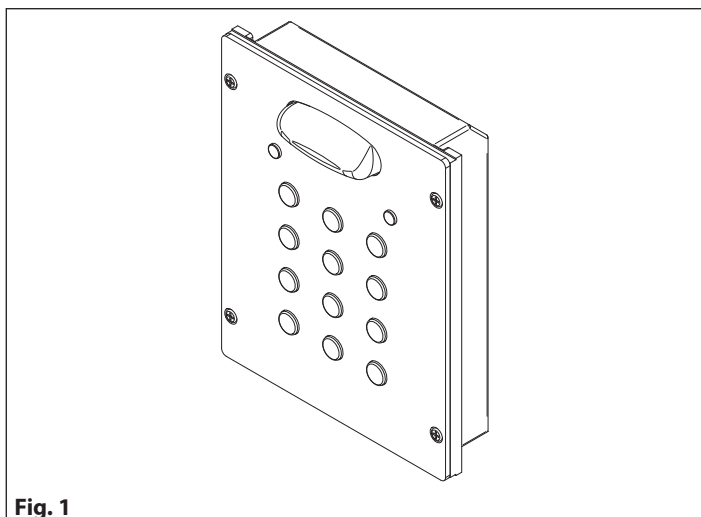

Fig. 1

DESCRIPTION

Access control system with 2 codes and 2 Relay outputs for Art. 8800 (3 codes and 3 Relay outputs for Art. 8800-3).

- Engineer's code to enter into the "Programming Menu" (from 4 to 8 digits).
- Programming of the activation time of each relay from 1 up to 99 seconds or latching.
- Possibility to activate relay 1 by shorting terminal **SW1** to GND and relay 2 by shorting terminal **SW2** to **GND**. Both relays will operate for the programmed time.
- Keypad gives an acoustic (buzzer) signal during the entering of codes and a continuous melody for 4 or more seconds, according to the number of mistakes (self protection).
- Keypad includes panel illumination and 2 LED's to show the following:
 - » Correct relay code (green LED on for 2 seconds).
 - » Red LED to indicate when in the "programming menu".

AVAILABLE VERSIONS

Art. 8800: Module 2 Relay with keypad illumination LEDs

Art. 8800-3: Module 3 Relay with keypad illumination LEDs

GENERAL DIRECTIONS FOR INSTALLATION

In order to achieve the best results from the schematics described it is necessary to install only original VIDEX equipment, strictly keeping to the items indicated on each schematic and follow these General Directions for Installation:

- The system must be installed according to national rules in force, in any case the running of cables of any intercom unit must be carried out separately from the mains;
- All multipair cables should be compliant to CW1308 specification (0.5mm twisted pair telephone cable).
 - » Cables for speech line and service should have a max resistance of 10 Ω
 - » Lock release wires should be doubled up (Lock release wires and power supply wires should have a max resistance of 3 Ω);
- The cable sizes above can be used for distances up to 50m. On distances above 50m the cable sizes should be increased to keep the overall resistance of the cable below the RESISTANCES indicated above;
- Double check the connections before power up;
- Power up the system then check all functions.

LOCK RELEASE BACK EMF PROTECTION

A varistor must be fitted across the terminals on AC lock release (**Fig.1A**) and a diode must be fitted across the terminals on a DC lock release (**Fig.1B**) to suppress back EMF voltages. Connect the components to the lock releases as shown in figures.

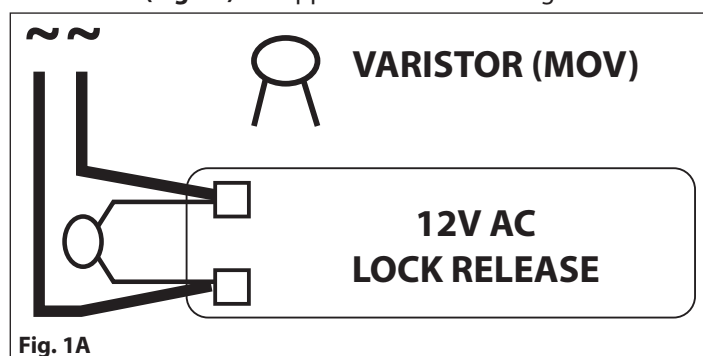

Fig. 1A

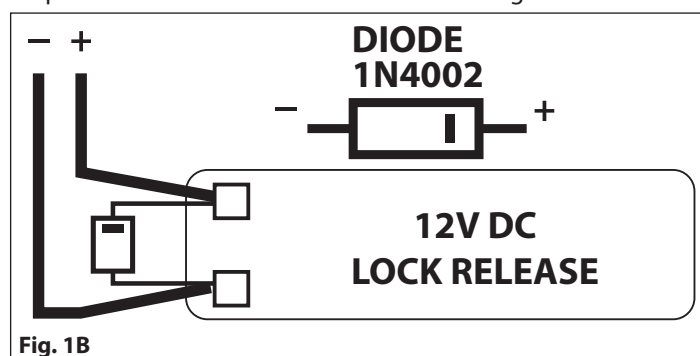

Fig. 1B

PROGRAMMING

- Enter **ENGINEER'S CODE**: first time type six times **1 (111111)** factory preset and press **ENTER** (The red LED will illuminate).
- Confirm **ENGINEER'S CODE** (typing again the same) or type the new code (4 to 8 digits) then press **ENTER** (Melody). Pressing twice the **ENTER** button without changing the **ENGINEER'S CODE**, will exit from the programming.
- Enter the code (4 to 8 digits) to enable **RELAY 1** (ACCESS 1) or re-enter the existing code then press **ENTER** (Melody).
- Enter the **RELAY 1** operation time (2 digits 01 to 99 **i.e.** 05=5 seconds, 00= remain open time) or re-enter the existing time then press **ENTER** (Melody).
- Enter the code (4 to 8 digits) to enable **RELAY 2** (ACCESS 2) or re-enter the existing code then press **ENTER** (Melody).
- Enter the **RELAY 2** operation time (2 digits 01 to 99 **i.e.** 05=5 seconds, 00=remain open time) or re-enter the existing time then press **ENTER** (Melody).
- Enter the code (4 to 8 digits) to enable **RELAY 3** (ACCESS 3 only for Art. 8800-3) or re-enter the existing code then press **ENTER** (Melody).
- Enter the **RELAY 3** (only for Art. 8800-3) operation time (2 digits 01 to 99 **i.e.** 05=5 seconds, 00=remain open time) or re-enter the existing time then press **ENTER** (Melody).
- The system is ready to use (the red LED will be off).

RETURN SYSTEM TO PRESET ENGINEER'S FACTORY CODE

- Turn off power to code lock;
- Keep **ENTER** button pressed while turning the power back on;
- Release **ENTER** button;
- The engineer's code is now set to **111111** (six times one).

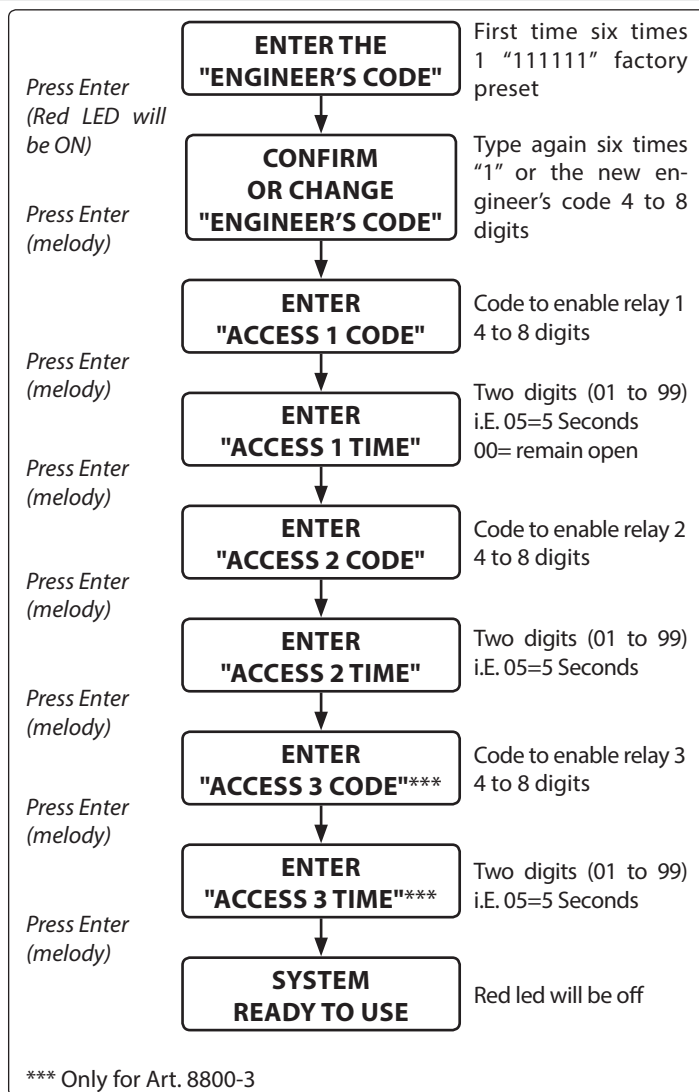

OPERATION

To use the system, type in the programmed code and press **ENTER**, the green LED will illuminate and the relay will operate for the programmed time. To cancel remain open time, type in the same code and press **CLEAR**. If a wrong code is entered, a continuous melody will sound for 4 or more seconds, according to the number of mistakes.

OPERATION NOTES

- To operate relays together, set the same code for each relay;
- If a wrong code is entered, the system will lock out for 5 seconds which will increase each time a wrong code is entered. The system will operate only when the correct code is entered.

RE-PROGRAMMING GUIDE

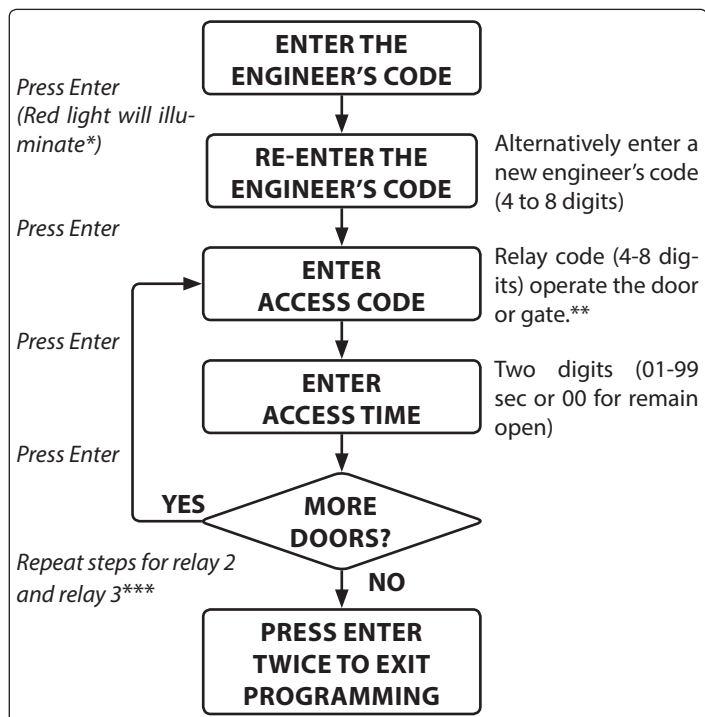

Engineer's code	
Relay 1 code	
Relay 2 code	
Relay 3 code***	
Relay 1 time	
Relay 2 time	
Relay 3 time***	

Notes:

- * If the red light does not illuminate, the engineer's code is incorrect. Follow instructions to return system to preset engineer's factory code.
- ** On the first loop of the flow chart its relay 1, second loop is relay 2 and third loop is relay 3.
- *** Only for Art. 8800-3

ART. 8800 CONNECTION TERMINALS SIGNALS

SW1	Relay 1 command signal (active low)	
SW2	Relay 2 command signal (active low)	
NC2	Relay 2 normally closed contact	Max 24Vac/dc 5A
NO2	Relay 2 normally open contact	
C2	Relay 2 common contact	
NC1	Relay 1 normally closed contact	
NO1	Relay 1 normally open contact	
C1	Relay 1 common contact	
$\sim/+$ $\sim/-$	12/24Vac/dc power input	

ART. 8800-3 CONNECTION TERMINALS SIGNALS

NO3	Relay 3 normally open contact	Max 24Vac/dc 5A
C3	Relay 3 common contact	
NC2	Relay 2 normally closed contact	
NO2	Relay 2 normally open contact	
C2	Relay 2 common contact	
NC1	Relay 1 normally closed contact	
NO1	Relay 1 normally open contact	
C1	Relay 1 common contact	
$\sim/+$ $\sim/-$	12/24Vac/dc power input	

TECHNICAL SPECIFICATIONS

Power requirements: 12/24V AC/DC, 2VA
Power Consumption: **On AC** **On DC**
 Stand-by: 82mA 21.5mA
 Operating: 125mA 35.0mA
Working Temperature: -10 +50° C

CLEANING OF THE PLATE

Use a clean and soft cloth. Use moderate warm water or non-aggressive cleansers.
Do not use:

- abrasive liquids;
- chlorine-based liquids;
- metal cleaning products.

8000 Series Surface and flush mounting door station installation

EXAMPLE: INSTALLING A TWO MODULE OUTDOOR STATION

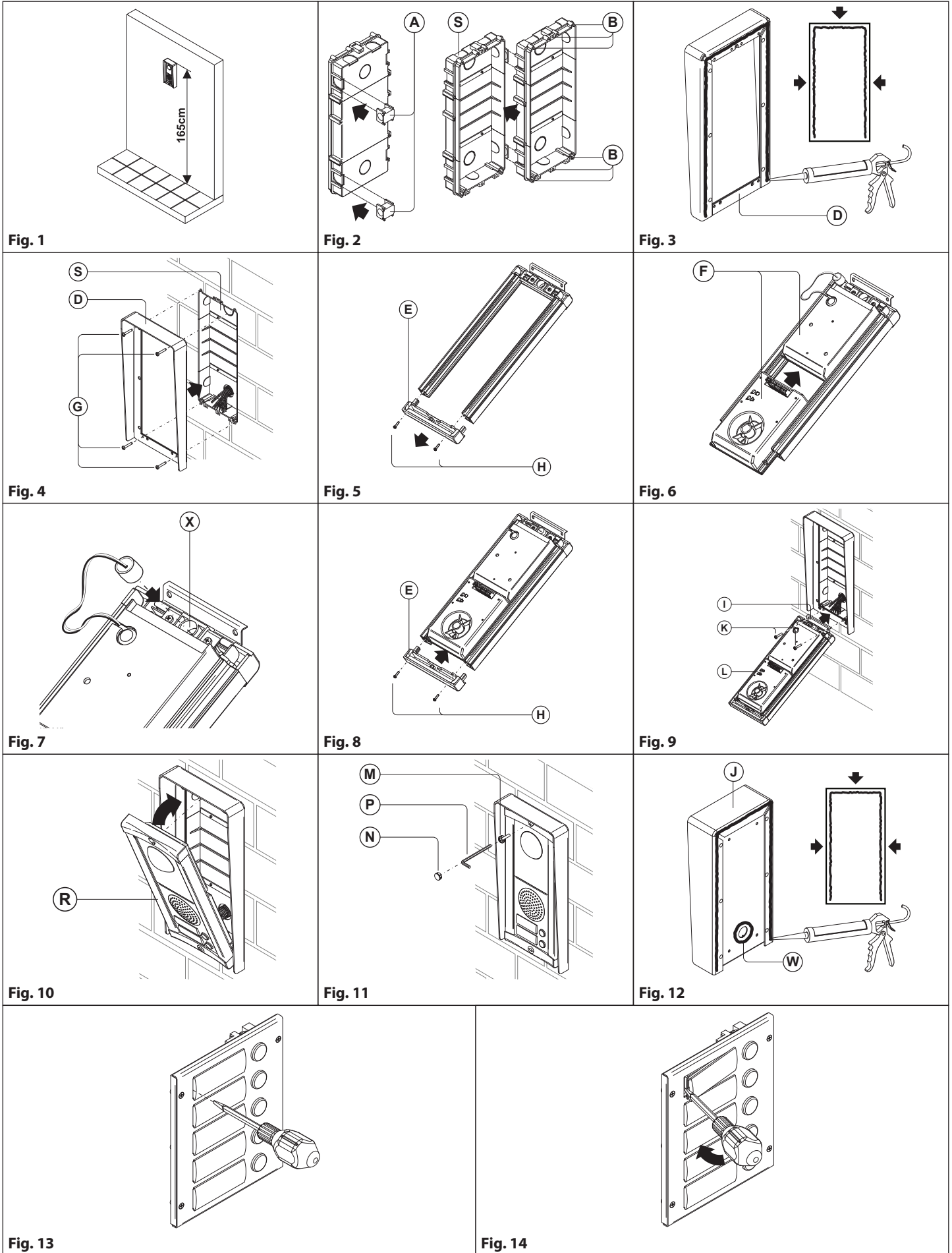

8000 Series Surface and flush mounting door station installation

INSTALLING A FLUSH MOUNTING DOOR STATION

1. Mount back box **(S)** (**Fig. 2**) at 165 cm from ground level (**Fig. 1**);
2. If more than one flush box is needed, connect them by using the plastic spacers provided **(A)** (**Fig. 2**);
3. If necessary finish and clean properly the module support fixing holes and all other holes **(B)** (**Fig. 2**);
4. A rainshield **(D)** (**Fig. 3 & 4**) can be mounted using the fixing screws **(G)** (**Fig. 4**) to conceal possible wall finishing defects and protect against rain;

 **In order to prevent water ingress we highly recommend using a silicon sealant between the wall and the back box and between the wall and the rainshield **(D)** (**Fig.3**);**

5. Remove the fixing screws **(H)** (**Fig. 5**) and remove the plastic cover **(E)** (**Fig. 5**) of the module support;
6. Insert the modules **(F)** (**Fig. 6**) according the required configuration;
7. Insert the microphone of the door unit amplifier into the microphone hole **(X)** (**Fig. 7**);
8. Secure the modules by refitting the plastic cover **(E)** (**Fig. 8**) and using the screws **(H)** (**Fig. 8**);
9. Insert the hinge **(I)** (**Fig. 9**) and fix it with the two screws **(K)** (**Fig. 9**) provided;
10. Make all connections following accurately the wiring diagram provided. Check the installation and if necessary adjust speech levels using volume controls **(L)** (**Fig. 9**);
11. Lever the support **(R)** (**Fig. 10**) upwards and fix it to the back box with the screw **(M)** (**Fig. 11**) using an alan key **(P)** (**Fig. 11**);
12. Conceal the screw using the plastic cover **(N)** (**Fig. 11**) provided.

INSTALLING A SURFACE MOUNTING DOOR STATION

Fix the surface box on the wall at a distance of 165 cm between the top of the box and the ground (**Fig. 1**).

 **In order to prevent water ingress we highly recommend using a silicon sealant between the wall and the back box **(J)** (**Fig.12**) and around all holes **(W)** (**Fig.12**).**

To complete the installation follow the same steps described above for the flush box.

 **Note: if additional holes are made in the box or rainshield, oxidation problems may appear unless the unprotected metal is coated with a protective paint.**

HOW TO REMOVE THE CARD NAME HOLDER

- To avoid damage to the module front plate, tape the side that will be in contact with the screwdriver blade;
- Insert a flat screwdriver into the card-holder hole as shown in **Fig. 13**;
- Move the screwdriver to the left as shown in **Fig. 14** to extract the card name holder;
- Edit the card name then replace it inside the holder and refit: insert the holder inside its housing from the left or right side then push the other side until it clips into place.

Art. 6458 4.3" hands free colour display digital videophone

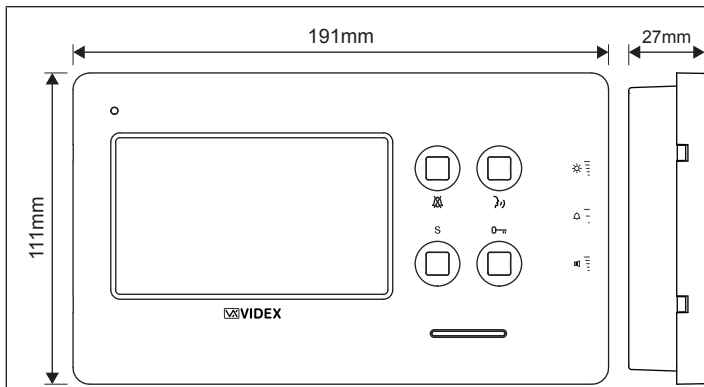

Fig. 1

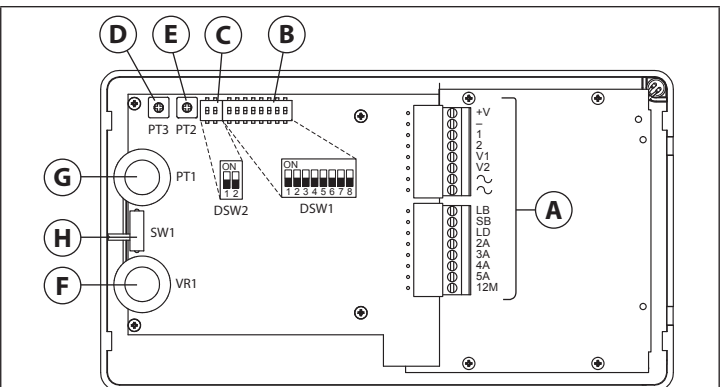

Fig. 2

DESCRIPTION

Surface mount hands free videophone incorporating a 4.3" Hi-Res full colour active matrix LCD monitor specific for "6 wire" videokit (VK4K, VK4KX, VRVK and VK8K range). It includes 4 buttons: "camera recall" "open door" "service" and "privacy".

3 LED's* indicate the privacy activated, open door and activated functions.

Programmable privacy duration, melody type and number of rings. Intercommunicating call and door call.







Adjustments: call tone volume switch (3 levels), picture hue, contrast and brightness.



* The operation of some LED's and the functions described may require additional cabling



LEGEND

- (A) Connection terminals
- (B) 8 Way dip switch bank
- (C) 2 Way dip switch bank
- (D) Contrast adjustment trimmer
- (E) Hue adjustment trimmer
- (F) Speech volume control
- (G) Brightness control
- (H) Call tone volume switch

PUSH BUTTONS



S	<p>Service push button. Shorts the SB terminal to GROUND (open collector 24Vdc 100mA max) while the button remain pressed.</p>
	<p>Privacy ON-OFF button. When the system is in stand-by, the pressing of this button activates (LED switched on) or disables (LED switched off) the "privacy" service. The service is automatically disabled when the programmed privacy time expires. When the service is enabled the videophone does not receive calls.</p>
	<p>Door-open / intercommunicating call button. With speech lines open to the entrance panel, press this button to open the door. If the terminal LD is properly connected the relevant LED remains switched ON until the door is closed. <u>Intercommunication only works when the system is in the stand-by condition.</u> Switch 4 of the SW1 dip-switch selects the type of intercommunication:</p> <p>OFF Intercommunication between two apartments - press the key button to call the videophone(s) in the other apartment. A busy tone will signal that the other videophone is in conversation with the door station and so cannot be called.</p> <p>ON Intercommunication between videophones in the same apartment - press the key button one, two, three or four times to call videophone with extension address 1, 2, 3 or 4 (Set on dip-switches 2&3 of SW1).</p> <p><u>Any intercommunicating conversation is always interrupted by an external call (i.e. External calls take priority).</u></p>
	<p>Intercommunication push button. For an intercommunicating call, press as many times as the extension or address value to call (see SW3 Intercommunication Settings).</p>
	<p>Answer push button. On an incoming call, pressing this button allows the user to answer and converse with the visitor. The relevant LED will illuminate.</p>
	<p>Switch off button. With the system switched on (monitor on), momentary operation of the button will switch the video monitor off. The videomonitor will also automatically switch off after a time delay if the button is not pressed. The relevant LED will switch off.</p>
	<p>Camera recall button. Press the button (Press once for door/gate 1, twice for 2 and so on up to a maximum of 4 entrances): the relevant LED switches ON and the monitor switches on showing the video from the door panel. The speech is also live and the door can be opened by pressing .</p>
	<p>Simplex button. Pressing and holding the button for more than 3 seconds will switch the videomonitor into SIMPLEX speech mode. Press and hold the button to speak to the caller ( LED will flash rapidly), release the button to listen ( LED will flash slowly). If the button is not pressed for 10 seconds the videomonitor will switch off. The videomonitor will revert to duplex speech when another call is made.</p>

LEDS	
	Privacy on LED It illuminates when the privacy service is enabled.
	Generic use LED It is controlled from the terminals +DOL and -DOL . Normally used to signal the door status (open or closed).
	ON LED It illuminates when the videophone is switched ON.

CONTROLS AND ADJUSTMENTS	
 PT1	Brightness control (sliding wheel).
 SW1	Call tone volume control (3 levels).
 VR1	Speech volume control (sliding wheel).
PT2	Colour intensity control trimmer (rotate left to increase or right to decrease).
PT3	Contrast control trimmer* (rotate left to increase or right to decrease). <small>*Not available in some LCD versions.</small>

SETTINGS (DIP-SWITCH)

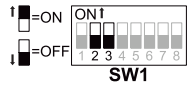

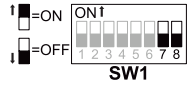
The videophone setup is carried out by the 2 dip-switch banks.

	Switch 1	Apartment Address
	OFF	1
	ON	2
	Switches 2,3	Extension Address
	OFF OFF	1
	ON OFF	2
	OFF ON	3
	ON ON	4
	Switch 4	Intercommunication
	OFF	Between videophones in another apartment
	ON	Between videophones in the same apartment
	Switches 5,6	Number of rings
	OFF OFF	2
	ON OFF	4
	OFF ON	6
	ON ON	8
	Switches 7,8	Privacy duration time
	OFF OFF	15 minutes
	ON OFF	1 hours
	OFF ON	4 hours
	ON ON	8 hours



2 WAY DIP-SWITCH (SW2)

	The two way dip-switch adjusts the impedance of the video signal. The default setting is "ON" for both switches (75 Ohm): when there are more videophones in parallel connection (without video distributor) both switches must be "ON" only on the last videophone (looking at the connection order) while for all other videophones both switches must be set to "OFF".
---	---

MELODY TYPE SETTING

- Press and keep pressed  button for 10 seconds to enter melody type programming mode: the unit plays the current melody and then a "beep";
- After the "beep" press  buttons to select the next melody: a new melody will play for some seconds then the unit emits a "beep". There are 9 melodies available. **Note:** press  buttons only after the melody is over and the unit emits the "beep";
- When desired melody is playing, wait for some seconds: the unit completes the melody and emits a "beep", then the unit emits a double "beep" that confirms the new setting is properly stored;
- The unit returns to stand-by mode.

Art. 6458 4.3" hands free colour display digital videophone**CONNECTION TERMINALS SIGNALS**

+V	20Vdc Input/Output (As input 16÷20Vdc 0,5A – as output 20Vdc 0,5A max)
-	Ground reference for +V terminal.
1	Speech line output from microphone and data signal (Approx. 12V in stand-by, 5V during a conversation)
2	Speech line input toward the loudspeaker (Approx. 12V in stand-by, approx. 3V during a conversation)
V1	Balanced video signal 1 sync.-
V2	Balanced video signal 2 sync.+
	24Vac 1A max power input
	

LB	Local call input (5V in standby, 0V to trigger)
SB	Service button (open collector) active low output. The button goes active when the button is pressed (Open Collector 24Vdc 100mA max)
LD	12Vdc input for door-open LED
2A	Speech line input toward the loudspeaker of the parallel telephone (Approx. 12V in stand-by, 3V during a conversation)
3A	Output switched ground for parallel telephone
4A	Output call tone for parallel telephone
5A	Input for door-open command from parallel telephone
12M	12Vdc power supply for Memory Board version

TECHNICAL SPECIFICATION

Power Supply:	24Vac in or 20Vdc in
Power consumption:	Stand-by: 50mA Max Operating: 250mA Max
Working Temperature:	-10 +50 °C

MEMORY BOARD

This device is also available in the version with memory board (Art. 6458/VM).

If you have that version, please refer to the "**6200, 6300, 6400 and 6700 Series Memory Board**" user manual (in English and Italian) for installation and use.

The manual is available for download: click/tap or scan the QR code.



6400 Series Wall mounting instructions

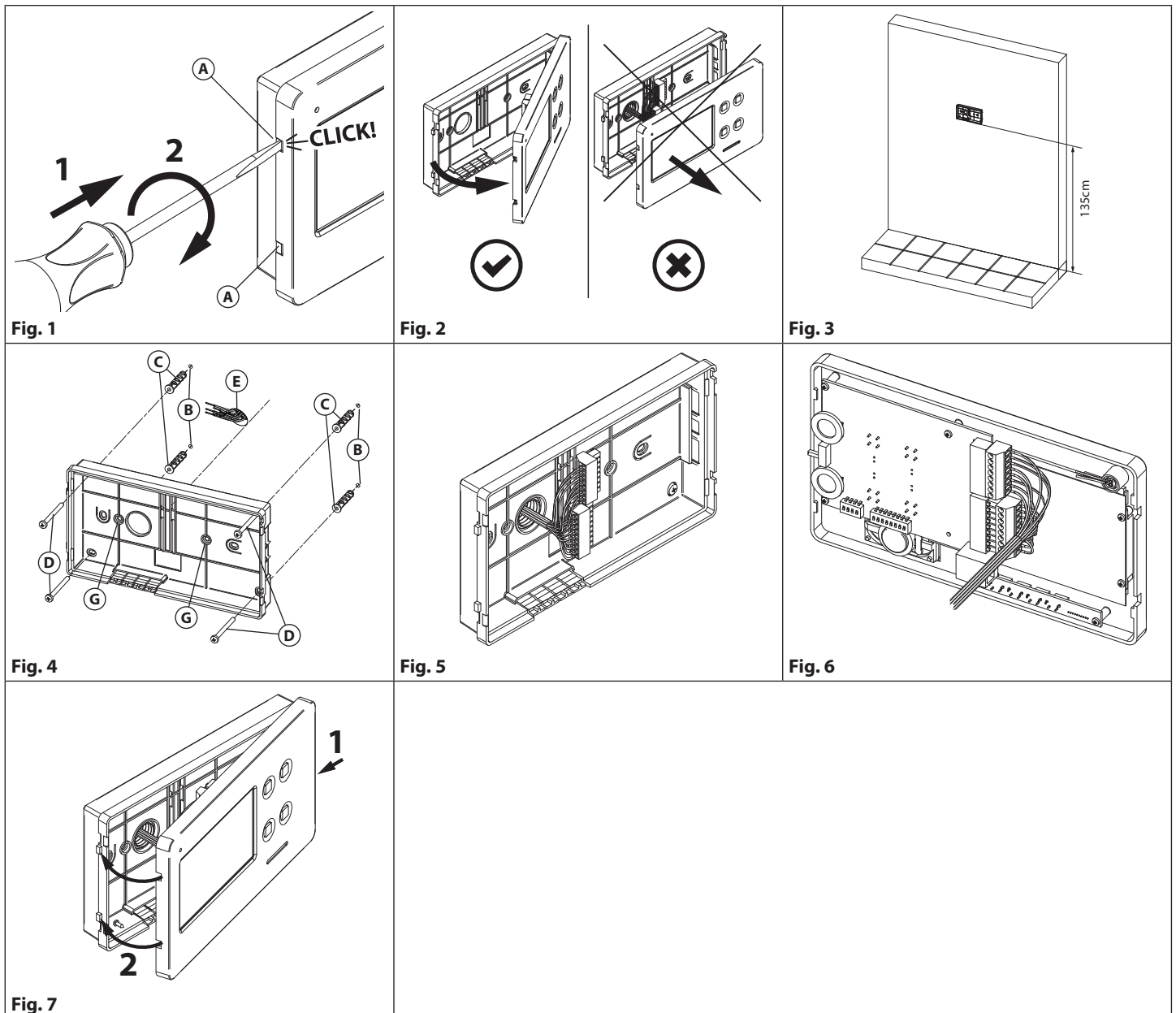

- In order to install the videophone, it is necessary to remove the cover, which contains all the electronics, from the base: insert a 5.5mm flat screw driver into the clip (A) then rotate clockwise until you listen a "CLICK!". Repeat the same operation with the other clip as shown in Fig. 1.
- Pull outwards the left part of the cover as shown in Fig. 2. **Don't pull the cover straight.**
- Put the base of the unit on the wall at approx 135cm from the finished floor (Fig. 3) to match the points for the fixing holes (B) (Fig. 4) remembering that the wires (E) (Fig. 4) must be fed through the large hole (F) (Fig. 4). If you use the flush mounting box 503, embed it into the wall vertically at approx. 140cm from the finished floor and the base.
- Following Fig. 4, make the holes (B), insert the wall plugs (C) and fix the base with the screws (D) feeding the wires (E) through the hole (F). If you have used the box 503, fix the base to the wall through the holes (G) using the screws (D).
- As shown in Fig. 5, connect the wires to the removable terminals following the provided installation diagram. Connect the terminal blocks to the electronics contained in the cover as shown in Fig. 6. Test system before closing.
Contrast and hue trimmers can be adjusted only if the videophone is open. To activate the display and see changes use the "Camera Recall" function by pressing  button.
Note: while testing the system, it is advisable to hold the cover with your hand.
- Once testing is complete and all the necessary adjustments are made, close the unit as shown in Fig. 7: first hook in the right part and then the left part until you hear a "CLICK!".

Art. 316 - Art. 316N

4 Way video distributor for system with balanced video signal

DESCRIPTION

ART. 316

4 Way video distributor for systems with balanced video signal. In white plastic ABS box 11x70x30mm surface mount.

ART. 316N

As Art. 316 but small form factor without terminals to connect "+" (plus) and "-" (minus) from videophones (is required an external connection of these terminals). It is housed in a 50X60X20 mm plastic box which is for surface mounting.

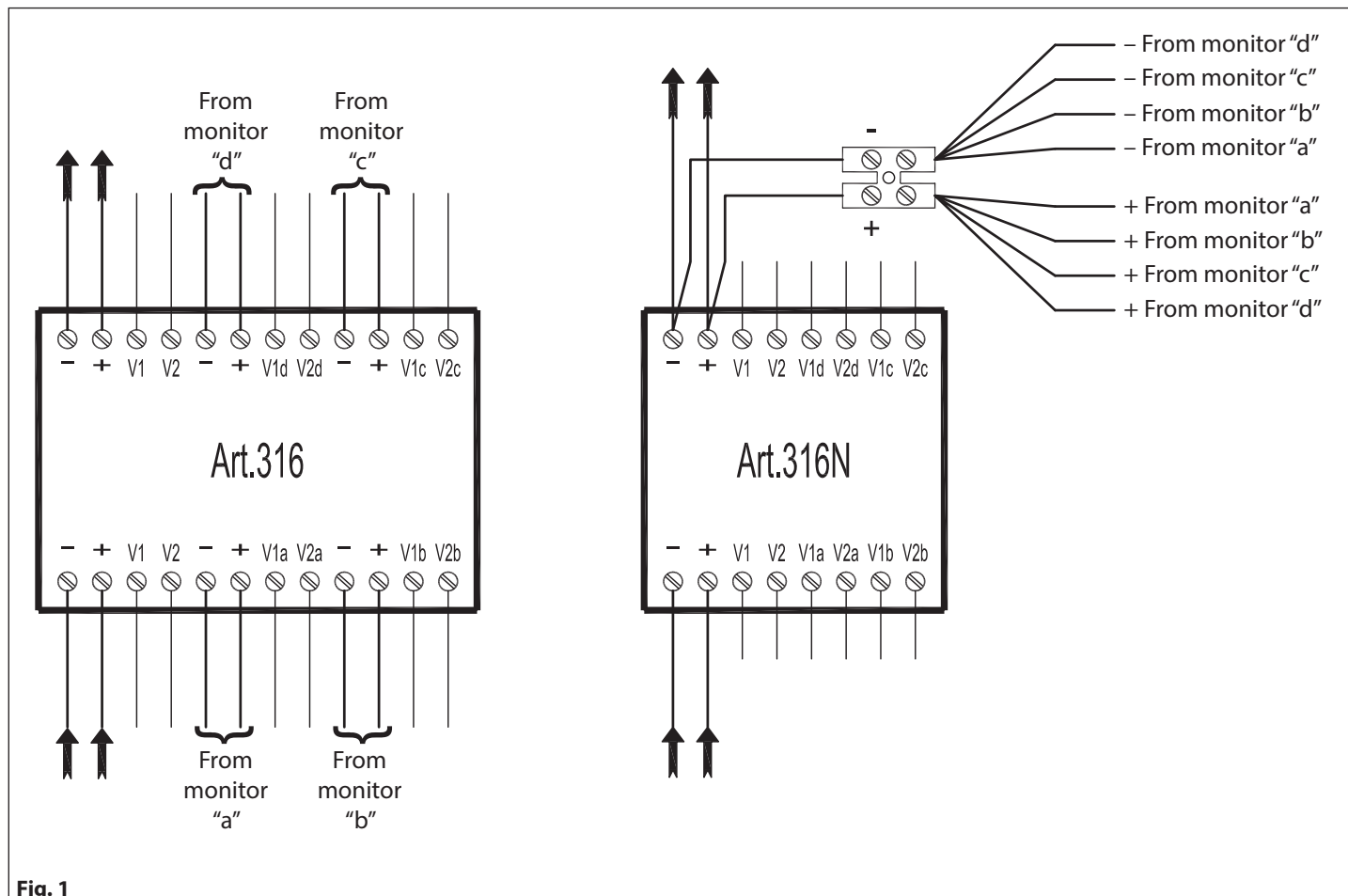
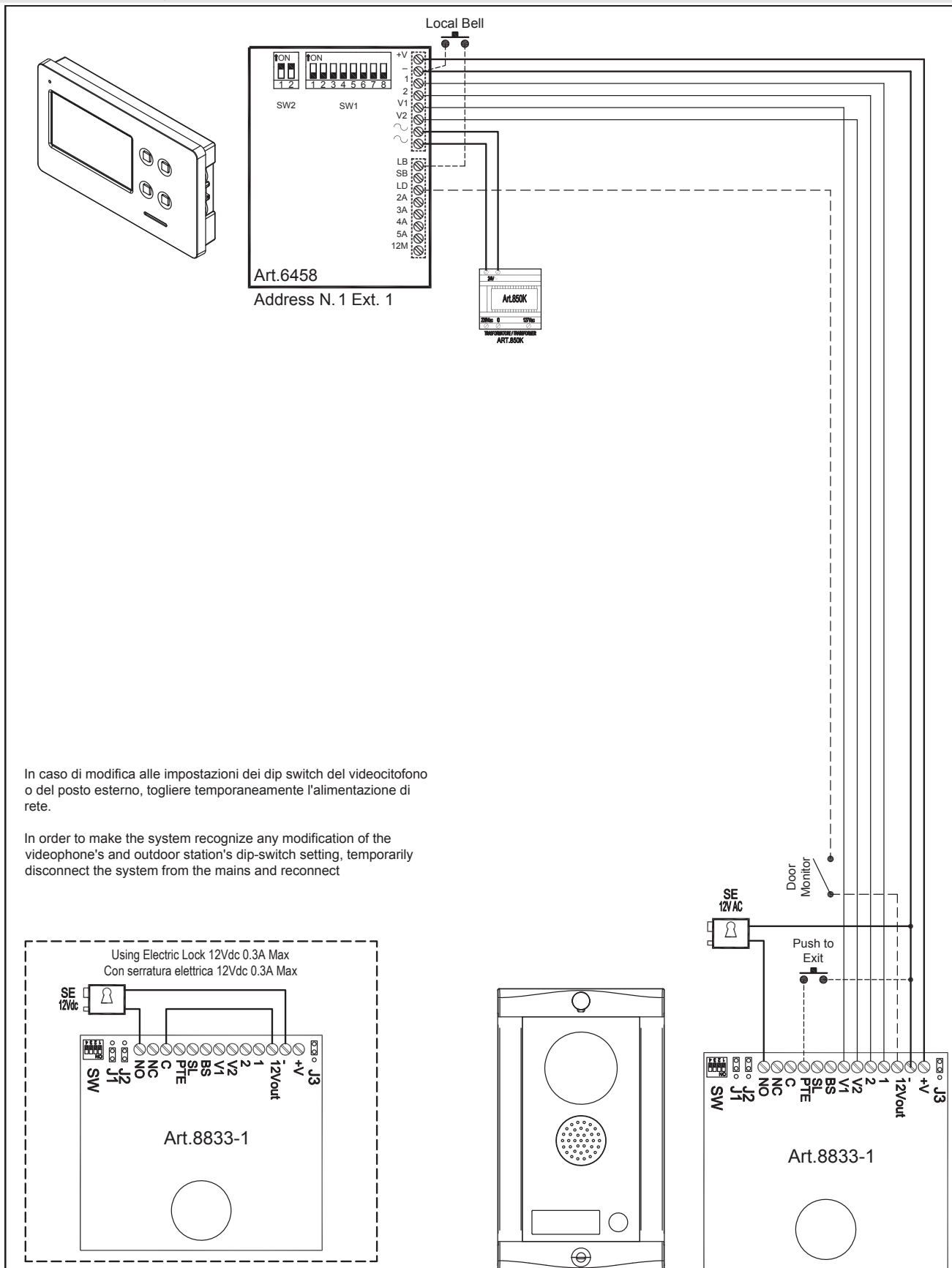

Fig. 1

VIDEOKIT VK8K-1/6458, VK8K-1S/6458



In caso di modifica alle impostazioni dei dip switch del videocitofono o del posto esterno, togliere temporaneamente l'alimentazione di rete.

In order to make the system recognize any modification of the videophone's and outdoor station's dip-switch setting, temporarily disconnect the system from the mains and reconnect

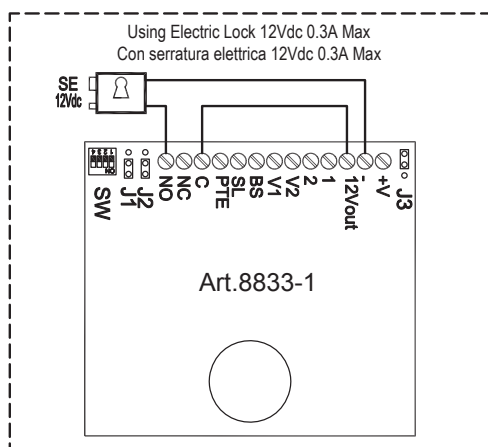

Title: VK8K-1/6458, VK8K-1S/6458		Date creazione: 03/12/2015	Foglio 1 / 1
Model: VK8K-1/6458, VK8K-1S/6458		Date modifica: 03/12/2015	
Notes: -		Autore: Marco Rongoni	
Notes: -		Cod File: vk8k64h-002.dwg	

VIDEOKIT VK8K-2/6458, VK8K-2S/6458

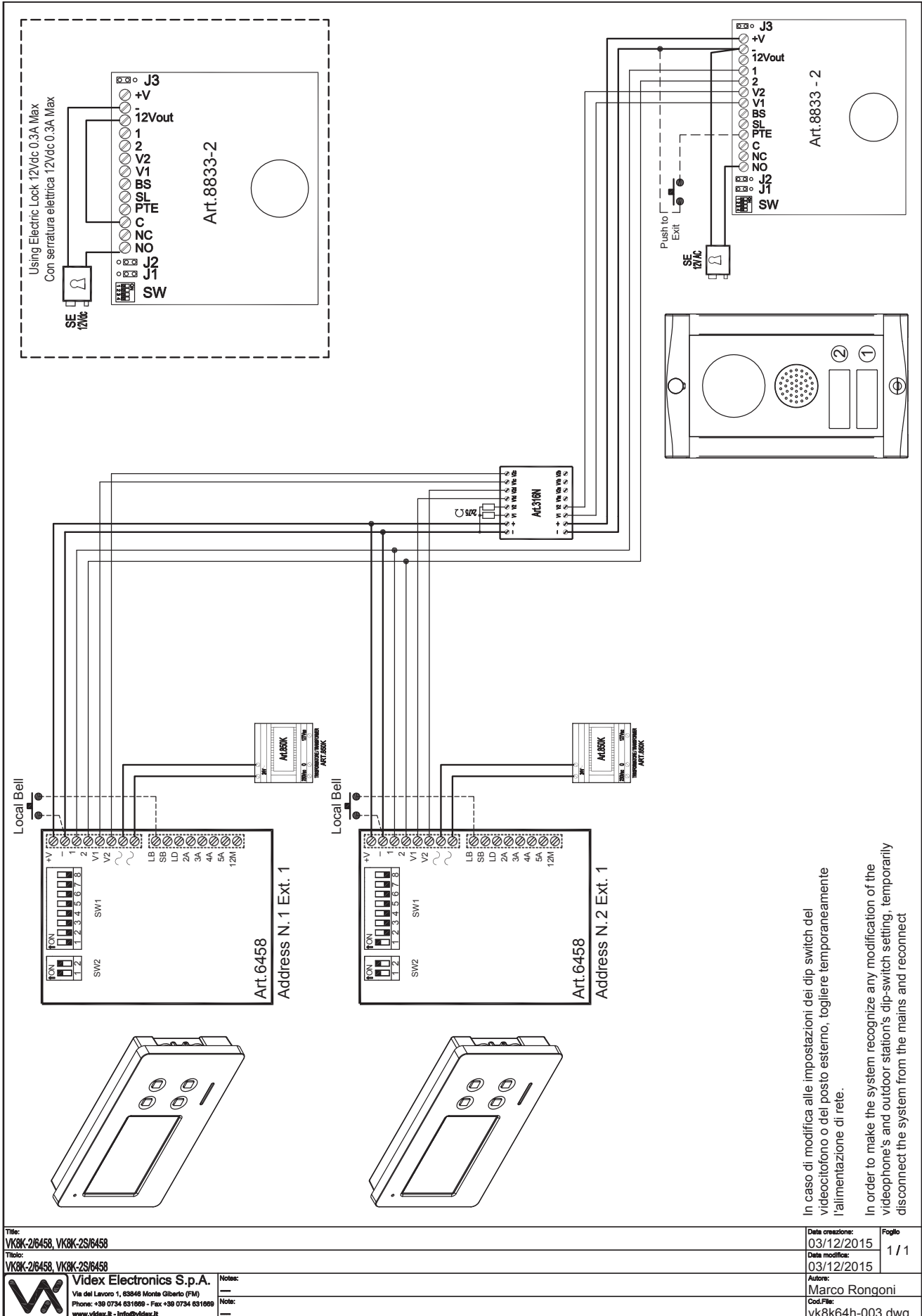

Title: VK8K-2/6458, VK8K-2S/6458		Date creazione: 03/12/2015	Foglio 1 / 1
Thico: VK8K-2/6458, VK8K-2S/6458		Data modifica: 03/12/2015	
Videx Electronics S.p.A. Via del Lavoro 1, 63046 Monte Giberto (FM) Phone: +39 0734 631669 - Fax: +39 0734 631669 www.videx.it - info@videx.it		Autore: Marco Rongoni	Cod.File: vk8k64h-003.dwg

VIDEOKIT VK8KC-1/6458, VK8KC-1S/6458

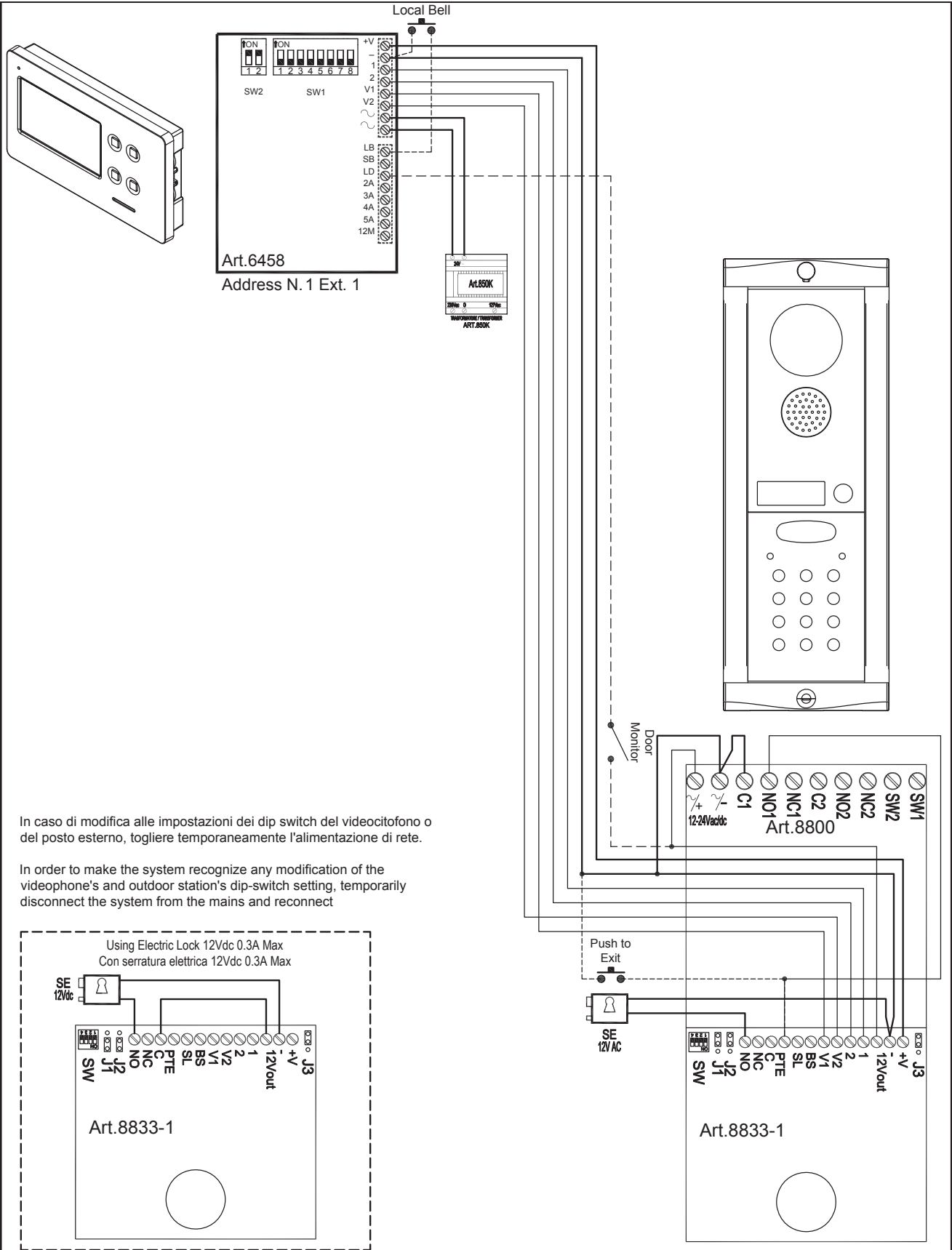

In caso di modifica alle impostazioni dei dip switch del videocitofono o del posto esterno, togliere temporaneamente l'alimentazione di rete.

In order to make the system recognize any modification of the videophone's and outdoor station's dip-switch setting, temporarily disconnect the system from the mains and reconnect

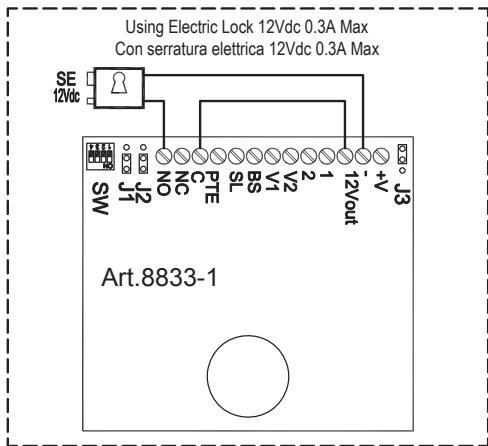

Titolo: VK8KC-1/6458, VK8KC-1S/6458		Data creazione: 03/12/2015	Foglio 1 / 1
Modello: VK8KC-1/6458, VK8KC-1S/6458		Data modifica: 03/12/2015	
Videx Electronics S.p.A. Via del Lavoro 1, 63846 Monte Giberto (FM) Phone: +39 0734 631669 - Fax: +39 0734 631669 www.videx.it - info@videx.it		Autore: Marco Rongoni Cod. File: vk8k64h-004.dwg	

VIDEOKIT VK8KC-2/6458, VK8KC-2S/6458

In caso di modifica alle impostazioni del dip switch del videocitofono o del posto esterno, togliere temporaneamente l'alimentazione di rete.

In order to make the system recognize any modification of the videophone's and outdoor station's dip-switch setting, temporarily disconnect the system from the mains and reconnect

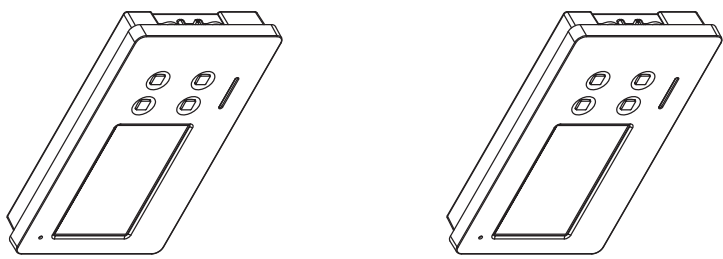
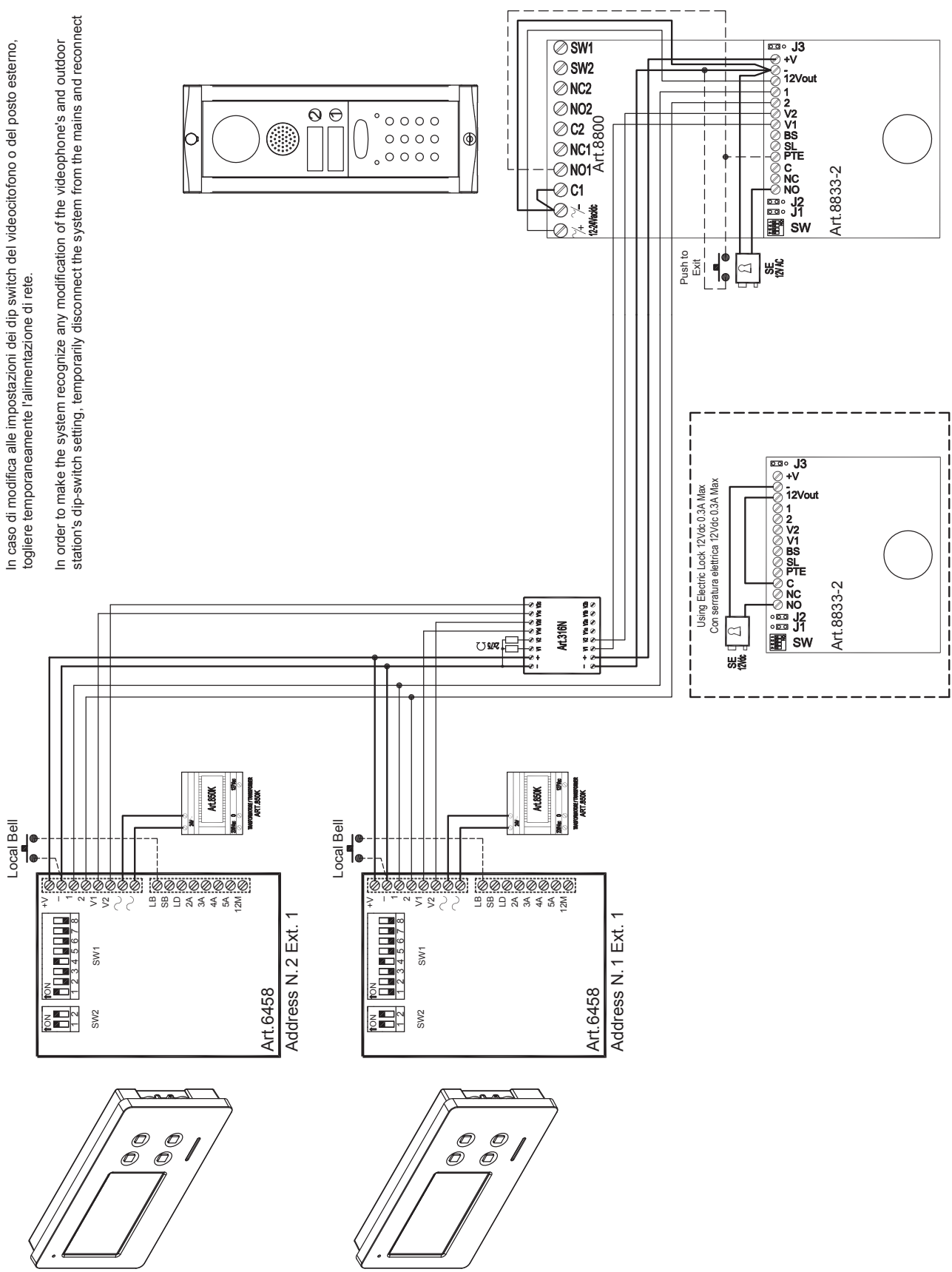

Title: VK8KC-2/6458, VK8KC-2S/6458		Date creazione: 03/12/2015	Foglio 1 / 1
Thico: VK8KC-2/6458, VK8KC-2S/6458		Date modifica: 16/12/2015	
Videx Electronics S.p.A. Via del Lavoro 1, 63046 Monte Giberto (FM) Phone: +39 0734 631669 - Fax: +39 0734 631669 www.videx.it - info@videx.it	Notes: -	Autore: Marco Rongoni	
	Notes: -	Cod.File: vk8k64h-005.dwg	

VIDEOKIT VK8K-1/6458, VK8K-1S/6458 WITH ADDITIONAL INTERCOM AND EXTENSION SOUNDER

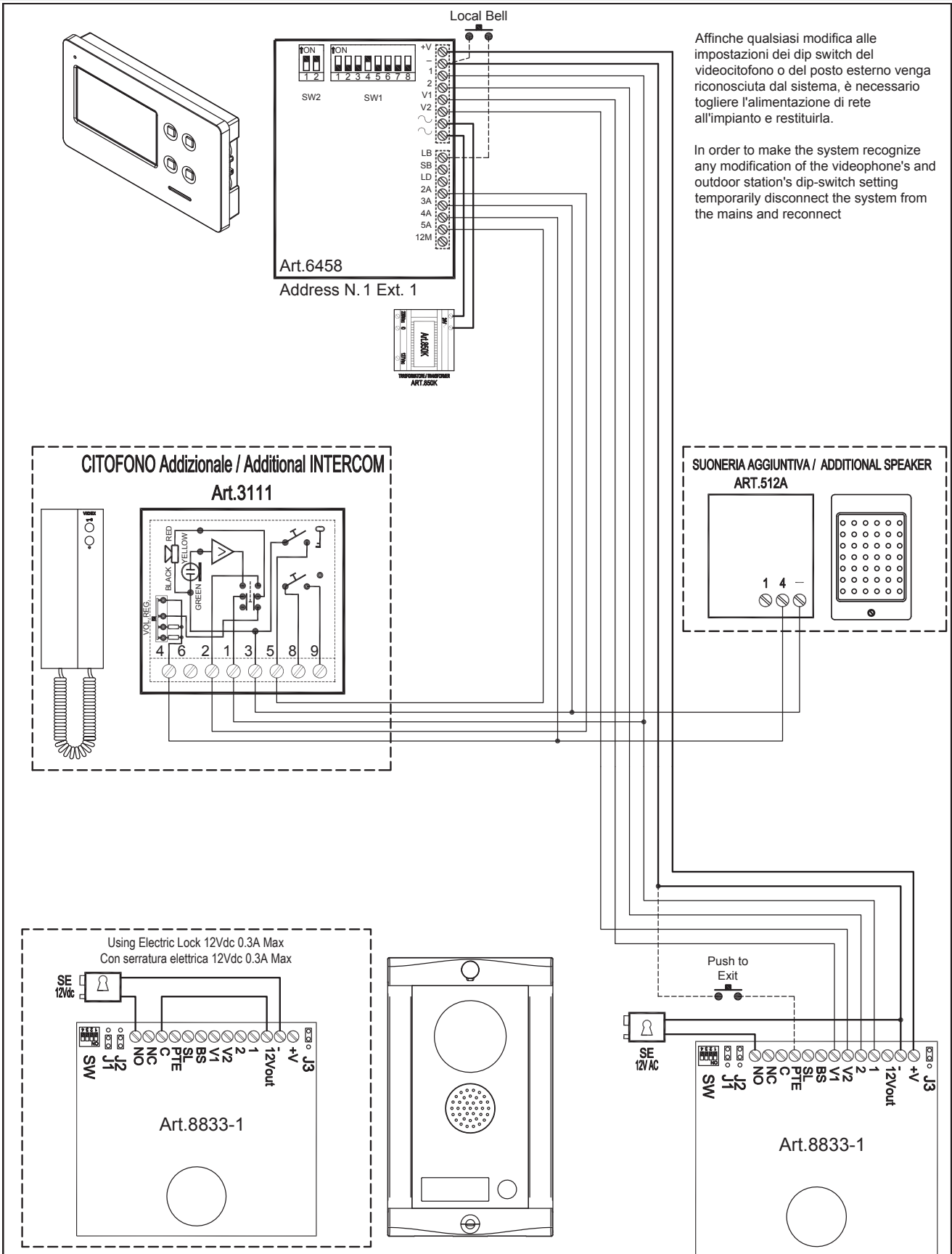

Affinché qualsiasi modifica alle impostazioni dei dip switch del videocitofono o del posto esterno venga riconosciuta dal sistema, è necessario togliere l'alimentazione di rete all'impianto e restituirla.

In order to make the system recognize any modification of the videophone's and outdoor station's dip-switch setting temporarily disconnect the system from the mains and reconnect

Titolo: VK8K-1/6358, VK8K-1S/6358 plus Additional handset and additional speaker.

Titolo: VK8K-1/6358, VK8K-1S/6358 plus citofono e suoneria aggiuntivi

Videx Electronics S.p.A.
 Via del Lavoro 1, 63846 Monte Giberto (FM)
 Phone: +39 0734 631669 - Fax: +39 0734 631669
 www.videx.it - info@videx.it

Notes:
 Note:

Data creazione:	03/12/2015	Foglio	1 / 1
Data modifica:	02/12/2015		
Autore:	Marco Rongoni		
Cod. File:	vk8k64h-006.dwg		

VIDEOKIT VK8K-2/6458, VK8K-2S/6458 WITH ADDITIONAL DOOR PANEL FOR 2 ENTRANCES SYSTEM

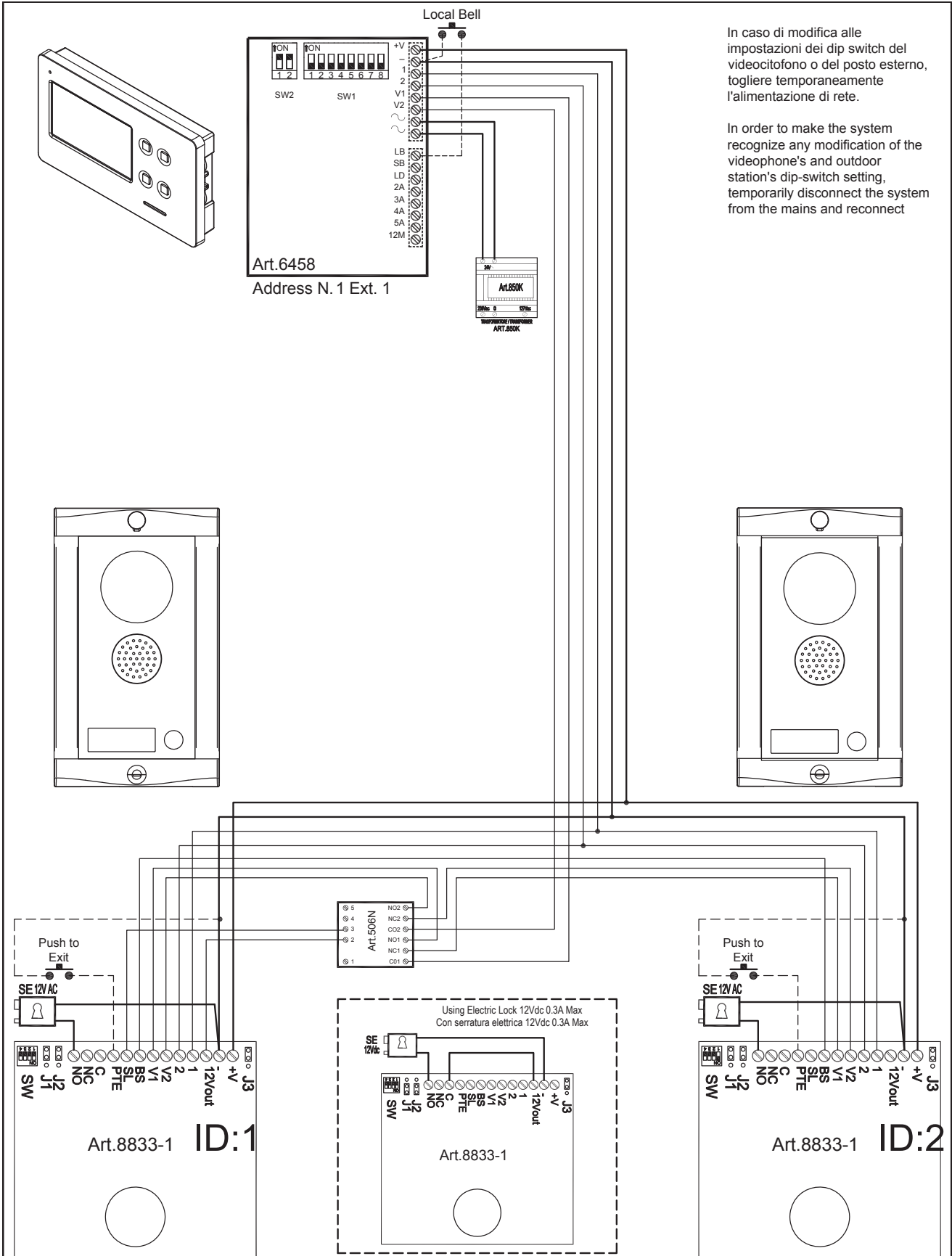



In caso di modifica alle impostazioni dei dip switch del videocitfono o del posto esterno, togliere temporaneamente l'alimentazione di rete.

In order to make the system recognize any modification of the videophone's and outdoor station's dip-switch setting, temporarily disconnect the system from the mains and reconnect

Titolo: VK8K-1/6458, VK8K-1S/6458 with second door panel for two entrances system		Data creazione:	Foglio
Titolo: VK8K-1/6458, VK8K-1S/6458 con secondo posto esterno per sistema a 2 ingressi		03/12/2015	1 / 1
Notes: Videx Electronics S.p.A. Via del Lavoro 1, 63846 Monte Giberto (FM) Phone: +39 0734 631669 - Fax: +39 0734 631669 www.videx.it - info@videx.it		Data modifica:	
		15/12/2015	
		Autore:	
		Marco Rongoni	
		Cod. File:	
		vk8k64h-007.dwg	

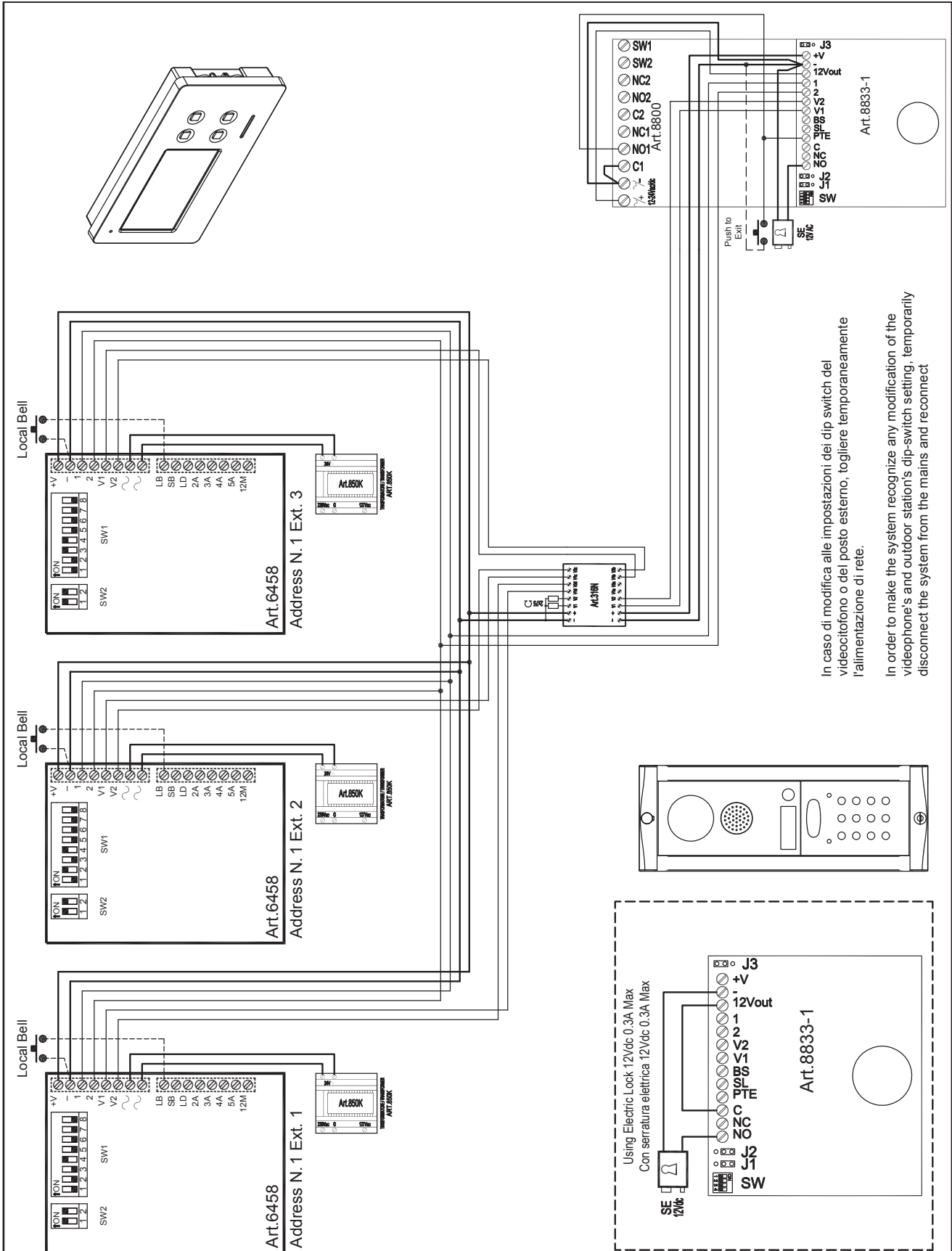
VIDEOKIT VK8KC-1/6458, VK8KC-1S/6458 WITH 3 ADDITIONAL VIDEOPHONES



Title: VK8KC-1/6458, VK8KC-1S/6458 + 2 additional videophones & Codelock unit Art.8800		Date creazione: 03/12/2015	Foglio 1 / 1
Theico: VK8KC-1/6458, VK8KC-1S/6458 + 2 videofoni addizionali e tastiera digitale Art.8800		Data modifica: 15/12/2015	
 Videx Electronics S.p.A. Via del Lavoro 1, 63046 Monte Giberto (FM) Phone: +39 0734 631669 - Fax: +39 0734 631669 www.videx.it - info@videx.it		Notes: Flat address of all videophones is the same while the extension address is different for each videophone Note: L'indirizzo principale è uguale per tutti mentre sono diversi gli indirizzi di interno	
		Autore: Marco Rongoni Cod.File: vk8k64h-008.dwg	

VIDEOKIT VK8K-2/6458 - VK8K-2S/6458 WITH ART. 316

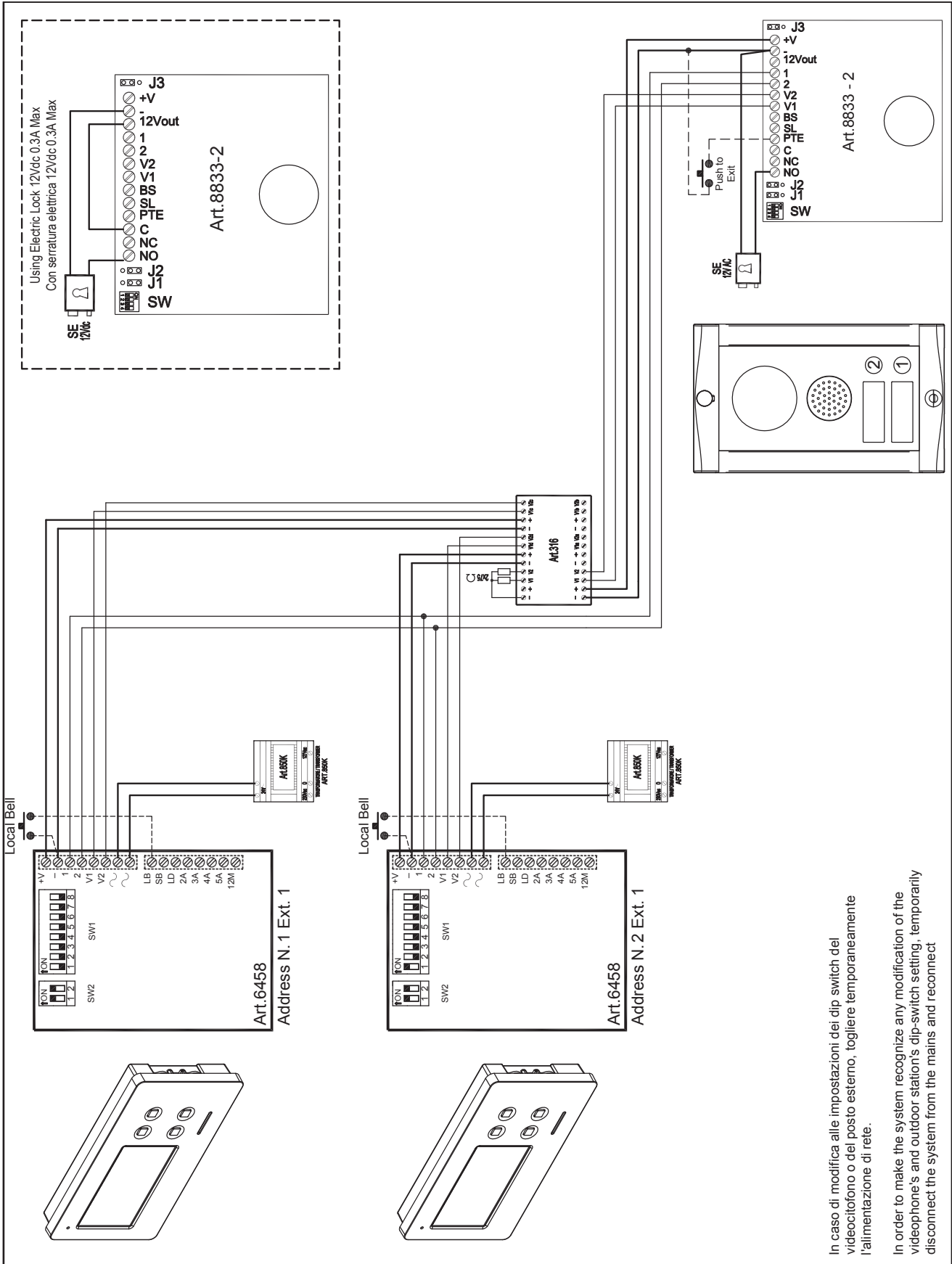

In caso di modifica alle impostazioni dei dip switch del videocitofono o del posto esterno, togliere temporaneamente l'alimentazione di rete.

In order to make the system recognize any modification of the videophone's and outdoor station's dip-switch setting, temporarily disconnect the system from the mains and reconnect

Title: VK8K-2/6458, VK8K-2S/6458		Date creazione: 03/12/2015	Foglio 1 / 1
Thico: VK8K-2/6458, VK8K-2S/6458		Date modifica: 03/12/2015	
 Videx Electronics S.p.A. Via del Lavoro 1, 63046 Monte Giberto (FM) Phone: +39 0734 631689 - Fax: +39 0734 631689 www.videx.it - info@videx.it		Autore: Marco Rongoni	
Note:		Cod.File: vk8k64h-001.dwg	

TWO ENTRANCES SYSTEM INSTALLATION

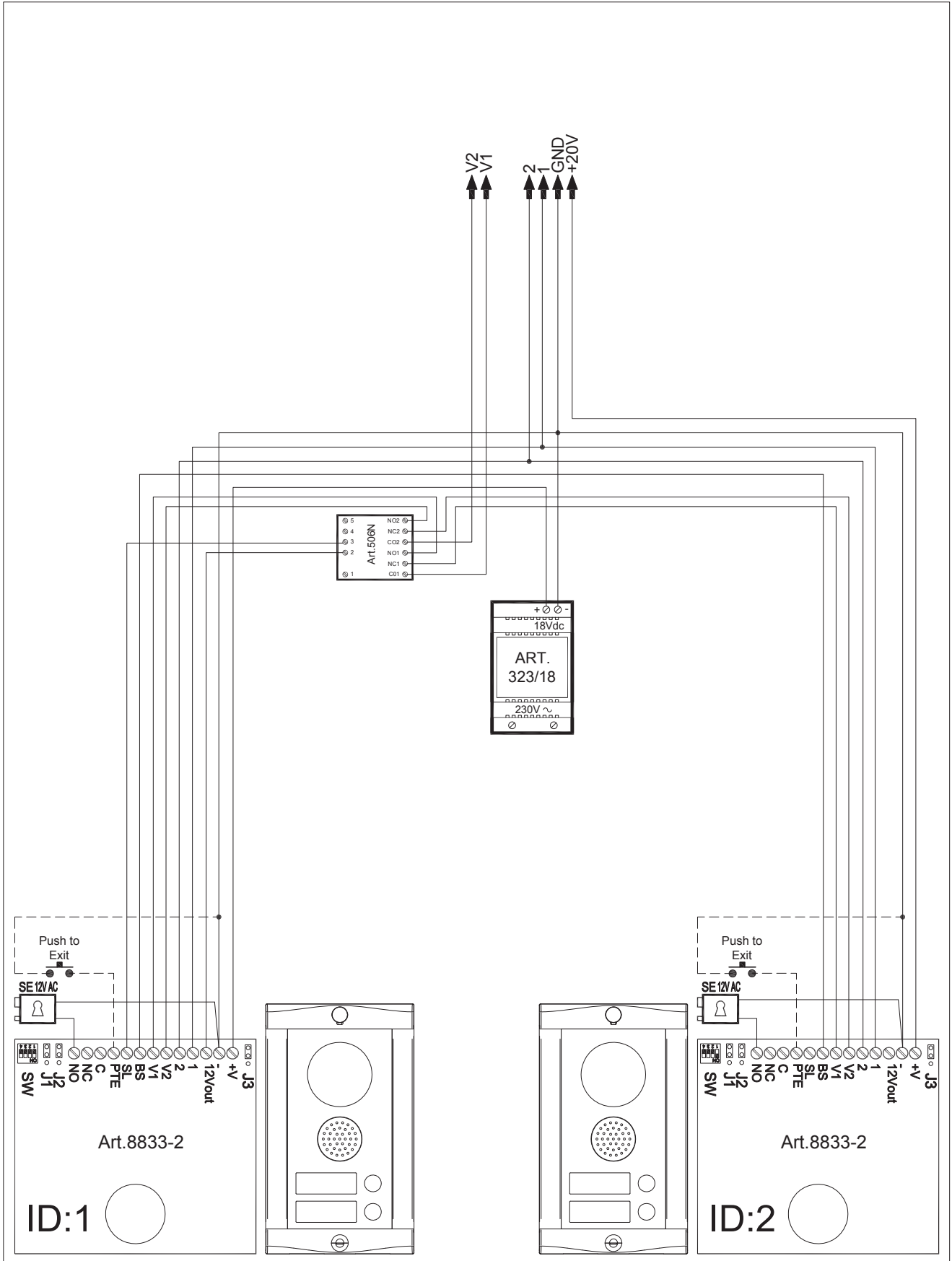

Titolo: VK8K-1/xxxx, VK8K-1/xxxx with second door panel for two entrances system		Data creazione:	28/10/2015	Foglio	1 / 1
Titolo: VK8K-1/xxxx, VK8K-1/xxxx con secondo posto esterno per sistemi a 2 ingressi		Data modifica:	28/10/2015		
Notes: --- Note: ---		Autore: Marco Rongoni Cod. File: vk8k-1-001-2e.dwg			

ENG DISPOSAL

In accordance with the Legislative Decree no. 49 of 14 March 2014 "Implementation of the Directive 2012/19/EU on waste electrical and electronic equipment (WEEE)".

The crossed-out bin symbol on the equipment or on the packaging indicates that when the product reaches the end of its lifetime, it must be collected separately from mixed municipal waste. The user must, therefore, dispose of the equipment at the end of its lifetime in the suitable waste collection centres or bring it to the retailer during the purchase of a new equipment of equivalent type at the ratio of one-to-one. Furthermore, the user is allowed to dispose of the WEEEs of very small size (domestic appliances without any external dimension exceeding 25 cm (9.84 inches) for free to the retailers, without any purchase obligation. The correct waste disposal of the WEEEs contributes to their reuse, recycling and recovery and avoids potential negative effects on the environment and human health due to the possible presence of dangerous substances within them.

ITA SMALTIMENTO

Ai sensi del Decreto Legislativo 14 marzo 2014, n° 49 "Attuazione della direttiva 2012/19/UE sui rifiuti di apparecchiature elettriche ed elettroniche (RAEE)".

Il simbolo del cassonetto barrato riportato sull'apparecchiatura o sulla sua confezione indica che il prodotto alla fine della propria vita utile deve essere raccolto separatamente dagli altri rifiuti urbani misti. L'utente dovrà, pertanto, conferire l'apparecchiatura giunta a fine vita presso gli idonei centri di raccolta differenziata oppure riconsegnarla al rivenditore al momento dell'acquisto di una nuova apparecchiatura di tipo equivalente, in ragione di uno a uno. L'utente ha, inoltre, la possibilità di conferire gratuitamente presso i distributori, senza alcun obbligo di acquisto, per i RAEE di piccolissime dimensioni (per le apparecchiature di tipo domestico con nessuna dimensione esterna superiore a 25 cm). L'adeguata raccolta differenziata dei RAEE contribuisce al loro riutilizzo, riciclaggio e recupero ed evita potenziali effetti negativi sull'ambiente e sulla salute umana dovuti alla eventuale presenza di sostanze pericolose al loro interno.

FRA ÉLIMINATION

Conformément au décret législatif n° 49 du 14 mars 2014 relatif à l'« Application de la directive 2012/19 / UE relative aux déchets d'équipements électriques et électroniques (DEEE) ».

Le symbole de la poubelle barrée sur l'équipement ou sur son emballage indique que le produit en fin de vie utile doit être collecté séparément des autres déchets municipaux en mélange. L'utilisateur doit donc remettre l'équipement en fin de vie aux centres de collecte appropriés ou le restituer au revendeur lors de l'achat d'un nouveau type d'équipement équivalent, dans le rapport de un à un. De plus, l'utilisateur a la possibilité de conférer gratuitement aux distributeurs, sans aucune obligation d'achat, de très petits DEEE (pour les appareils ménagers sans dimensions extérieures supérieures à 25 cm). La collecte séparée adéquate des DEEE contribue à leur réutilisation, leur recyclage et leur valorisation et évite les éventuels effets négatifs sur l'environnement et la santé humaine en raison de la présence possible de substances dangereuses dans ceux-ci.

SPA ELIMINACIÓN

De conformidad con el Decreto legislativo n. 49 de 14 de marzo 2014 "Aplicación de la Directiva 2012/19/UE relativa a residuos de aparatos eléctricos y electrónicos (RAEE)".

El símbolo del contenedor tachado indicado sobre los aparatos o sobre los embalajes señala que el producto al final de su vida útil debe ser recogido separadamente de otros residuos municipales mezclados. Por tanto, el usuario deberá conferir los aparatos al final de su vida útil en los apropiados centros de recogida selectiva o devolverlos al revendedor al momento de la compra de nuevos aparatos equivalentes, en una relación de uno a uno. Además, el usuario tiene la posibilidad de entregar sin cargo a los distribuidores, sin ninguna obligación de compra, los RAEEs muy pequeños (para electrodomésticos sin dimensiones externas superiores a 25 cm).

La recogida selectiva apropiada de los RAEEs contribuye a su reutilización, reciclaje y valorización y evita potenciales impactos negativos sobre el medio ambiente y la salud humana debidos a la posible presencia de sustancias peligrosas dentro de ellos.

NLD VERWIJDERING

In overeenstemming met het Wetsbesluit nr. 49 van 14 maart 2015 "Implementatie van de Richtlijn 2012/19/EU inzake afgedankte elektrische en elektronische apparaten (AEEA)".

Het doorgekruiste vuilnisbaksymbool op het apparaat of de verpakking geeft aan dat het product aan het einde van zijn levensduur niet samen met het gewone huisvuil weggegooid mag worden. De gebruiker moet het apparaat aan het einde van zijn levensduur inleveren bij een gepast inzamelpunt of de winkel waar hij een nieuw apparaat van een gelijksoortig type zal kopen. De gebruiker kan tevens AEEA's van een zeer klein formaat (huishoudapparaten met een buitenafmeting kleiner dan 25 cm (9,84 inch)) gratis en zonder enige aankoopverplichting bij handelaars inleveren. Een juiste verwijdering van AEEA's draagt bij tot hergebruik, recycling en terugwinning, en voorkomt potentiële negatieve effecten op het milieu en de menselijke gezondheid door de mogelijke aanwezigheid van gevaarlijke stoffen.

MANUFACTURER FABBRICANTE FABRICANT FABRICANTE FABRIKANT الشركة المصنعة	VIDEX ELECTRONICS S.P.A. Via del Lavoro, 1 63846 Monte Giberto (FM) Italy Tel (+39) 0734 631669 Fax (+39) 0734 632475 www.videx.it - info@videx.it	
CUSTOMER SUPPORT SUPPORTO CLIENTI SUPPORTS CLIENTS ATENCIÓN AL CLIENTE KLANTENDIENST خدمة العملاء	VIDEX ELECTRONICS S.P.A. www.videx.it - technical@videx.it Tel: +39 0734-631669 Fax: +39 0734-632475	UK Customers only: VIDEX SECURITY LTD www.videxuk.com Tech Line: 0191 224 3174 Fax: 0191 224 1559

*Main UK office:***VIDEX SECURITY LTD**

1 Osprey Trinity Park
Trinity Way
LONDON E4 8TD
Phone: (+44) 0370 300 1240
Fax: (+44) 020 8523 5825
www.videxuk.com
marketing@videxuk.com

*Northern UK office:***VIDEX SECURITY LTD**

Unit 4-7
Chillingham Industrial Estate
Chapman Street
NEWCASTLE UPON TYNE - NE6 2XX
Tech Line: (+44) 0191 224 3174
Phone: (+44) 0370 300 1240
Fax: (+44) 0191 224 1559

*Greece office:***VIDEX HELLAS Electronics**

48 Filolaou Str.
11633 ATHENS
Phone: (+30) 210 7521028
(+30) 210 7521998
Fax: (+30) 210 7560712
www.videx.gr
videx@videx.gr

*Danish office:***VIDEX DANMARK**

Hammershusgade 15
DK-2100 COPENHAGEN
Phone: (+45) 39 29 80 00
Fax: (+45) 39 27 77 75
www.videx.dk
videx@videx.dk

*Benelux office:***NESTOR COMPANY NV**

E3 laan, 93
B-9800 Deinze
Phone: (+32) 9 380 40 20
Fax: (+32) 9 380 40 25
www.videx.be
info@videx.be

*Dutch office:***NESTOR COMPANY BV**

Business Center Twente (BCT)
Grotestraat, 64
NL-7622 GM Borne
www.videxintercom.nl
info@videxintercom.nl



The product is CE marked demonstrating its conformity and is for distribution within all member states of the EU with no restrictions. This product follows the provisions of the European Directives 2014/30/EU (EMC); 2014/35/EU (LVD); 2011/65/EU (RoHS); CE marking 93/68/EEC.

Le produit est marqué CE à preuve de sa conformité et peut être distribué librement à l'intérieur des pays membres de l'union européenne UE.
Ce produit est conforme aux directives européennes 2014/30/EU (EMC); 2014/35/EU (LVD); 2011/65/EU (RoHS); marquage CE 93/68/EEC.

Het product heeft de CE-markering om de conformiteit ervan aan te tonen en is bestemd voor distributie binnen de lidstaten van de EU zonder beperkingen. Dit product volgt de bepalingen van de Europese Richtlijnen 2014/30/EU (EMC); 2014/35/EU (LVD); 2011/65/EU (RoHS); CE-markering 93/68/EEC.

Il prodotto è marchiato CE a dimostrazione della sua conformità e può essere distribuito liberamente all'interno dei paesi membri dell'Unione Europea UE. Questo prodotto è conforme alle direttive Europee: 2014/30/UE (EMC); 2014/35/UE (LVD); 2011/65/UE (RoHS); marcatura CE 93/68/EEC.

El producto lleva la marca CE que demuestra su conformidad y puede ser distribuido en todos los estados miembros de la unión europea UE.
Este producto cumple con las Directivas Europeas 2014/30/EU (EMC); 2014/35/EU (LVD); 2011/65/EU (RoHS); marca CE 93/68/EEC.

يحمل المنتج علامة التوافق الأوروبي CE لإظهار توافقه مع المواصفات ذات الصلة وإمكانية توزيعه في كافة دول الاتحاد الأوروبي بدون أية قيود. يلبّي هذا المنتج جميع متطلبات التوجيهات الأوروبية 2014/30/UE (EMC); 2014/35/UE (LVD); 2011/65/UE (RoHS) - (EMC); 2014/35/UE (LVD); 2011/65/UE (RoHS) - (EMC); 2014/35/UE (LVD); 2011/65/UE (RoHS); علامة المطابقة للمواصفات الأوروبية 93/68/EEC.



66250863-EN