



*Standalone Biometric Reader*



INSTALLER'S MANUAL

# Contents

<b>INTRODUCTION</b>	3
<b>MOUNTING</b>	3
<b>SPECIFICATIONS</b>	4
<b>APPLICATION DIAGRAM</b>	4
<b>RECOMMENDED SWIPING TECHNIQUE</b>	4
<b>INDICATION</b>	4
<b>WIRING</b>	5
<b>ADDING ADMIN FINGER</b>	5
<b>PAIRING - BIOMETRIC READER AND REMOTE RELAY UNIT</b>	6
Pairing B100-SA v2 with DINRTT	6
Pairing B100-SA v2 with RTT	6
Pairing B100-SA v2 with RU2	6
<b><u>ADMINISTRATOR PROGRAMMING</u></b>	7
ADD Finger Relay 1	7
ADD Finger Relay 2	7
ADD Finger Relay 1&2	7
DELETE Finger	7
DELETE ALL Fingers	8
CHANGE ADMIN Finger	8
CHANGE INSTALLER Finger	8
Administrator Programming block diagram	8
<b><u>INSTALLER PROGRAMMING</u></b>	9
Set Relay 1 Time	9
Set Relay 2 Time	9
BUZZER ON/OFF	9
BACKLIGHT ON/OFF	9
Installer Programming block diagram	10

## INTRODUCTION

B100-SA v2 is access control fingerprint reader designed for easy management of the users and configuration. The scanner is made with advanced capacitive sensing technology that provides some advantages over optical solutions like:

- making almost impossible to make fake copy of the users fingers
- same performance in the different light conditions
- good reading of fingers with stains from daily jobs

Built in strong scanning and matching algorithm provides excellent tolerance in the way finger is swiped over the sensor reducing to minimum the need to repeat finger swiping at the sensor.

The reader can store up to 100 finger templates. One template is reserved for User manager (Administrator), one template is reserved for Reader configuration (Installer) and up to 98 templates are for Users.

## RECOMMENDATIONS

Consult with installer about safety level of the installation. There are devices with relays compatible with this reader that can increase the security of the system if needed. One or two enrolled fingers are enough for one user. Ask the installer before he leaves the site to enroll your finger as administrator.

## NOTES

The Reader is using physical roughness of the fingerprint to scan the finger. Some of the users may have very flat fingertips, making difficult for the sensor to recognize correctly the fingerprint. In most cases, these are children and older persons. To solve this problem, do the following:

1. Try with different user's fingers to find the "best" finger.
2. Check with the installer other models of the reader with added card reader or keypad for other type of access.

## MAINTENANCE

No special or periodic maintenance is required. If cleaning is needed, use soft wet cloth and wipe gently the dirt. Do not use chemicals and materials that can scratch the sensor.

## WARNING!

Do not touch the sensor with other objects than finger. Do not pour or splash with water or other liquids. When painting or construction work is ongoing in the area around the reader, protect the reader sensor area from possible damages and paint. If reader is to be dismantled or relocated, call authorized installer for the job. Disposal of this product must be handled according to all national laws and regulations.

## MOUNTING

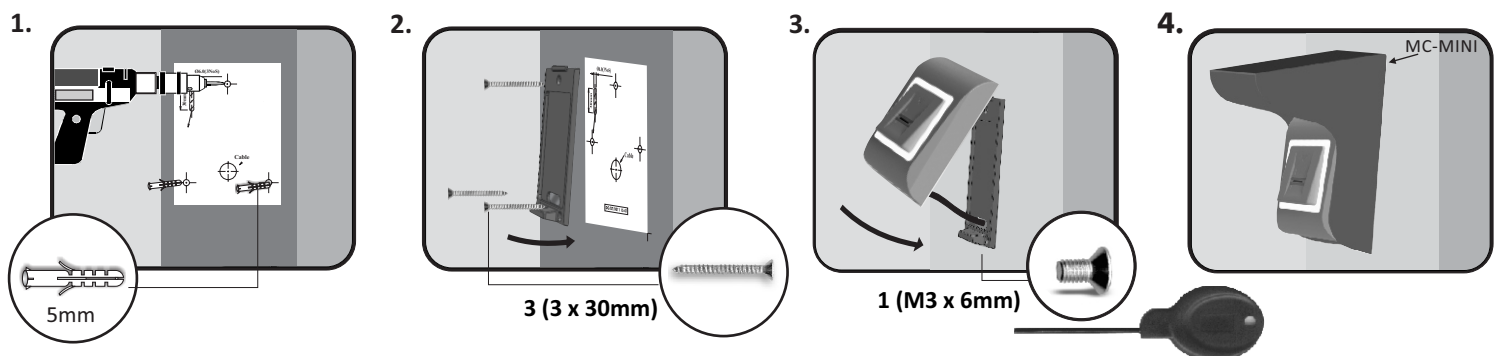

Do not install the device and cabling close to a source of strong electro-magnetic fields like radio-transmitting antenna.

Do not place the device near or above heating equipments.

If cleaning, do not spray or splash water or other cleaning liquids but wipe it out with smooth cloth or towel.

Do not let children touch the device without supervision.

Note that if the sensor is cleaned by detergent, benzene or thinner, the surface will be damaged and the fingerprint can't be entered.

If the biometric reader is installed and used outdoor, the reader MUST be fitted with the MC-MINI metal cover available in our accessories in order to protect the sensor from direct rainfall. The operating temperature of the product is between -20°C - + 50°C. If the reader is installed in an environment where the temperature can drop below -10°C or/and if the sensor could only be exposed to direct sunlight, it is strongly recommended to install the reader inside a third party sealed wall mount box (fitted with additional heater if very low temperature) to keep a constant sensor level performance. Videx™ cannot guarantee the functionality of the product if measures and advice before are not followed.

It is also strongly recommended to use double technology biometric readers when use outdoor to offer first higher security but also the possibility to use different readers depending on users.

## SPECIFICATIONS

Fingerprint Capacity:	98 templates
Output:	1 x Relay (2 A /24V AC/DC)
Push Button Input:	Yes
Door Open Time:	Pulse (1 to 30 seconds) or Toggle (ON/OFF)
Entry Mode:	Finger
Programming:	By swiping
Admin/Installer Fingers:	1 Administrator and 1 Installer Finger
Backlight ON/OFF:	Yes
Buzzer ON/OFF:	Yes
Firmware upgrade:	via RS485 converter and windows application
Current Consumption:	100 mA max.
Power Supply:	9-14 V DC
Indication:	Tricolor Status LED
IP Factor:	IP65
Storage/Operating Temperature:	-20°C to +50°C
Storage/Operating Humidity:	5% to 93% RH without condensation
Dimensions(mm):	92 x 51 x 25

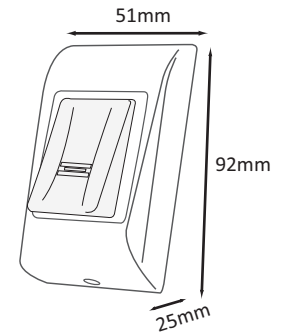

**B100-SA v2**

## APPLICATION DIAGRAM

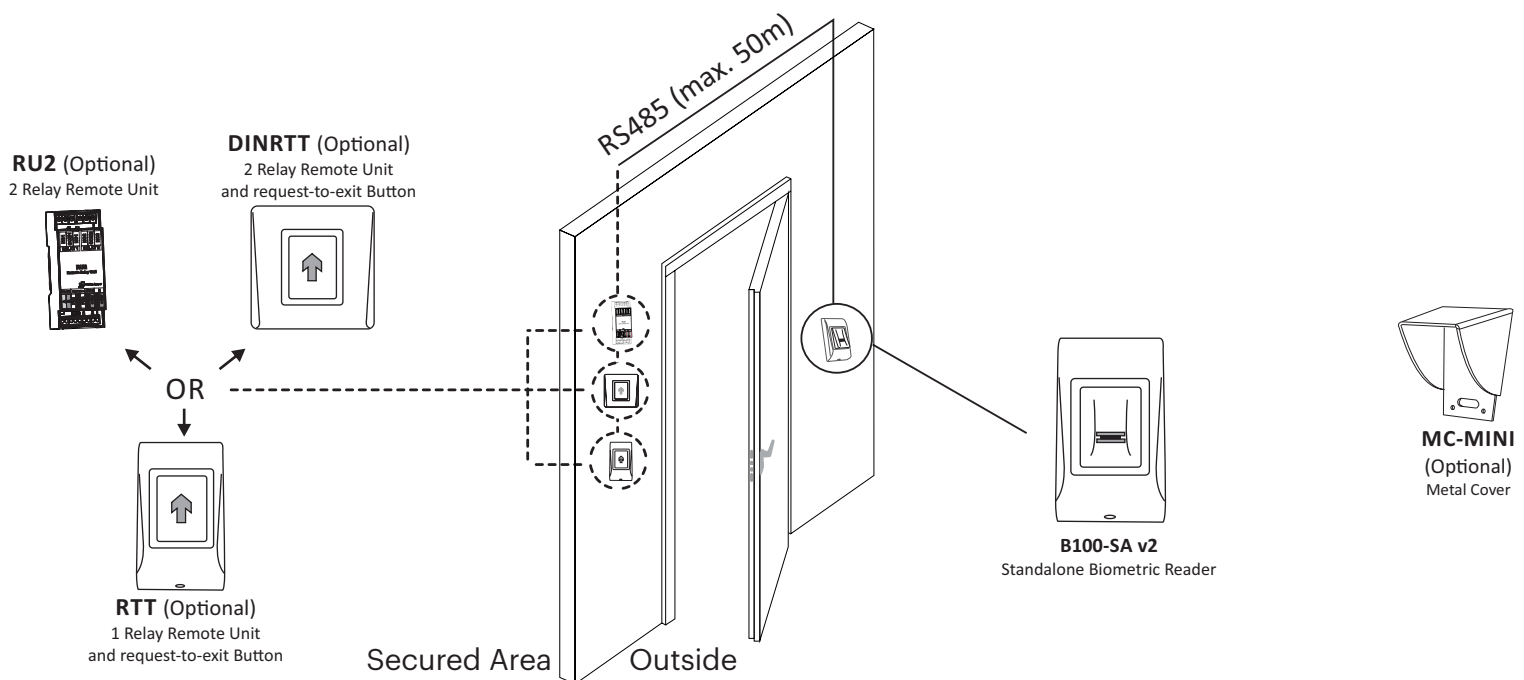

## RECOMMENDED SWIPING TECHNIQUE

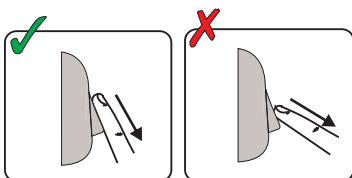

Follow the below instructions for correct finger swiping. Starting from the first finger joint, place the selected finger on the swipe sensor and move it evenly towards oneself in one steady movement.

Result:

For a valid swipe: Tricolour Status LED turns green + OK Beep(short + long beep)

For an invalid or misread swipe: Tricolour Status LED turns red + Error Beep ( 3 short beeps)

## INDICATION

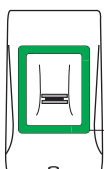

**Tricolor Status LED**  
 Green - Access Granted  
 Red - Access denied  
 Orange - Idle Mode

**OK Beep** - short + long beep

**Error Beep** - 3 short beeps

**Swipe Finger** - 2 short beeps

# WIRING

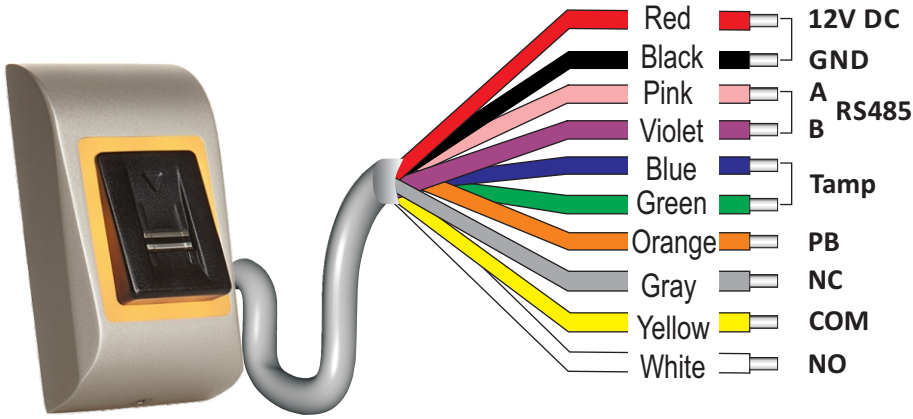

Colour	Connection
Red	12V DC
Black	GND
Green	Tamper
Blue	Tamper
Orange	Push Button
Pink	A (RS485)
Violet	B (RS485)
Grey	NC
Yellow	COM
White	NO

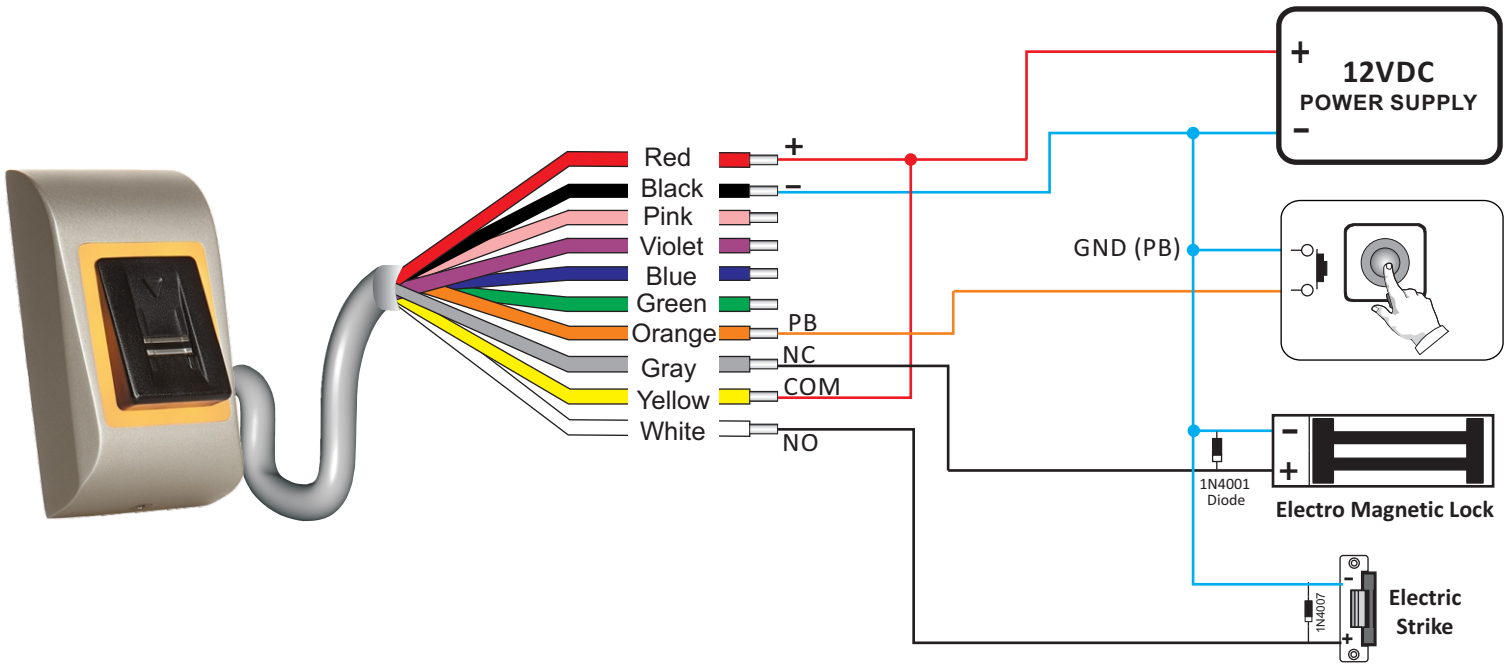

# ADDING ADMIN FINGER

1. Push dip switch no.2 in position ON.



2. Reset the Power of the device.



3. Wait for One long + multiple short beeps

4. Put the dip switch in position OFF. (short beeps will stop)



5. Wait for about **15 seconds** for the LED to blink in **Orange**.



6. Swipe the Admin finger min.6 times. (Until Ok Beep)



**Warning:** This procedure also deletes all the users and the installer finger.

**Warning:** This procedure will unpair the connected relay unit (RTT, DINRTT or RU2)

# PAIRING - BIOMETRIC READER AND REMOTE RELAY UNIT

If secure installation is needed, the reader can be connected to remote relay unit at secured area, which also can play the role of request-to-exit push button. Follow the instructions bellow to pair(couple) both devices or refer to the Remote Relay's Manual.

## Pairing B100-SA v2 with DINRTT

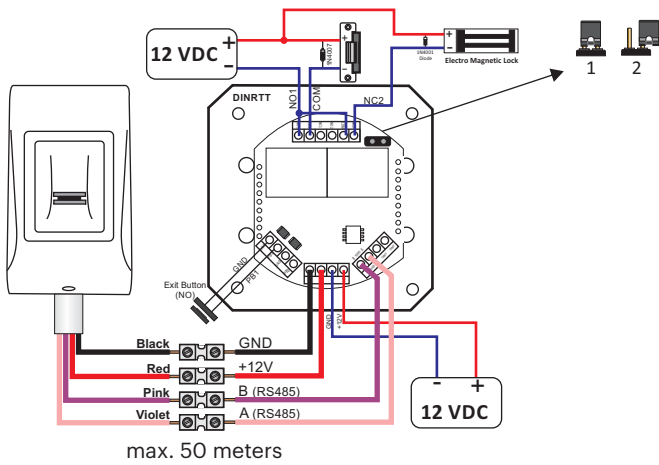

1. Close the Jumper. DINRTT beeps continuously and the red led blinks.
2. Open the Jumper
3. Wait for Beep + OK Beep (short + short + long beep)

After the OK beep, the coupling is done.

## Pairing B100-SA v2 with RTT

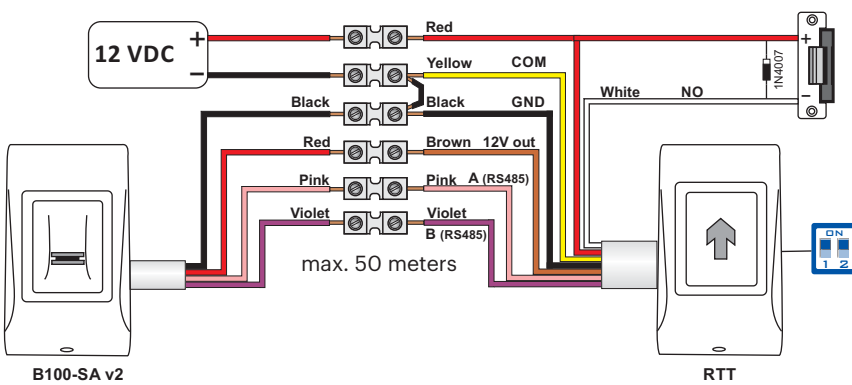

1. Put Dipswitch No.1 to position ON. RTT beeps continuously and the red led blinks.
2. Put Dipswitch No.1 to position OFF.
3. Wait for Beep + OK Beep (short + short + long beep)

After the OK beep, the coupling is done.

## Pairing B100-SA v2 with RU2

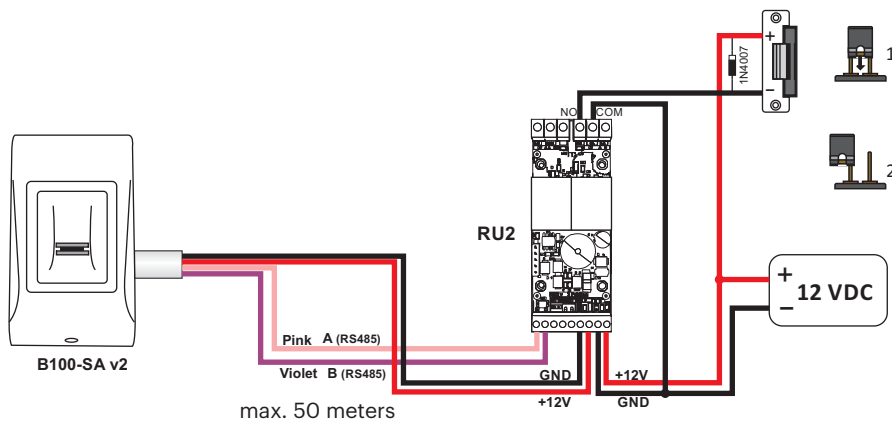

1. Put the Jumper to closed position. RU2 beeps continuously and the red led blinks.
2. Put the Jumper to open position.
3. Wait for Beep + OK Beep (short + short + long beep)

After the OK beep, the coupling is done.



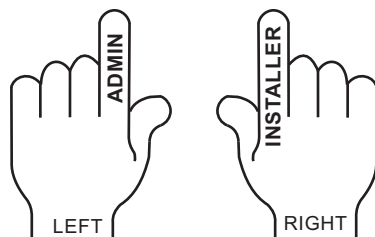

**Warning:** Changing the ADMIN finger will also unpair the remote relay unit.

# ADMINISTRATOR PROGRAMMING





Use point fingers as Administrator and Installer. You can use the other fingers as access fingers. Administrator finger is enrolled at the end of the system installation. Initial enrollment of the Admin finger is described in installer manual.



## ADD Finger Relay 1 (Finger that will activate relay 1)





Action	Finger	Backlight	Buzzer Sound
Swipe Admin Finger 1 time	 x 1	 slow blinking	short beep
Wait 5 seconds (until fast blinking)			short beep
Swipe User Finger min. 6 times (until short + long beep)	 x 6	 fast blinking	short + long beep

## ADD Finger Relay 2 (Finger that will activate relay 2)

Action	Finger	Backlight	Buzzer Sound
Swipe Admin Finger 2 times	 x 2	 slow blinking	short beep
Wait 5 seconds (until fast blinking)			short beep
Swipe User Finger min. 6 times (until short + long beep)	 x 6	 fast blinking	short + long beep





Relay 2 is available if the reader is used with remote relay unit with 2 relays(DINRTT and RU2). Consult the installer if Relay 2 is available in your system.

## ADD Finger Relay 1&2 (Finger that will activate relay 1&2)





Action	Finger	Backlight	Buzzer Sound
Swipe Admin Finger 3 times	 x 3	 slow blinking	short beep
Wait 5 seconds (until fast blinking)			short beep
Swipe User Finger min. 6 times (until short + long beep)	 x 6	 fast blinking	short + long beep

Relay 2 is available if the reader is used with remote relay unit with 2 relays(DINRTT and RU2). Consult the installer if Relay 2 is available in your system.





## DELETE Finger

Action	Finger	Backlight	Buzzer Sound
Swipe Admin Finger 4 times	 x 4	 slow blinking	short beep
Wait 5 seconds (until fast blinking)			short beep
Swipe User Finger	 x 1	 fast blinking	short + long beep





## ➤ DELETE ALL Fingers

Action	Finger	Backlight	Buzzer Sound
Swipe Admin Finger 4 times	 x 4	 slow blinking	short beep
Wait 5 seconds (until fast blinking)		 slow blinking	short beep
Swipe Admin Finger 2 times	 x 2	 fast blinking	multiple beeps

## ➤ CHANGE ADMIN Finger

Action	Finger	Backlight	Buzzer Sound
Swipe Admin Finger 5 times	 x 5	 slow blinking	short beep
Wait 5 seconds (until fast blinking)		 slow blinking	short beep
Swipe NEW Admin Finger min.6 times	 x 6	 fast blinking	short + long beep

## ➤ CHANGE/ADD INSTALLER Finger

Action	Finger	Backlight	Buzzer Sound
Swipe Admin Finger 6 times	 x 6	 slow blinking	short beep
Wait 5 seconds (until fast blinking)		 slow blinking	short + long beep
Swipe NEW Installer Finger min.6 times	 x 6	 fast blinking	3 short beeps

## ➤ Administrator Programming block diagram



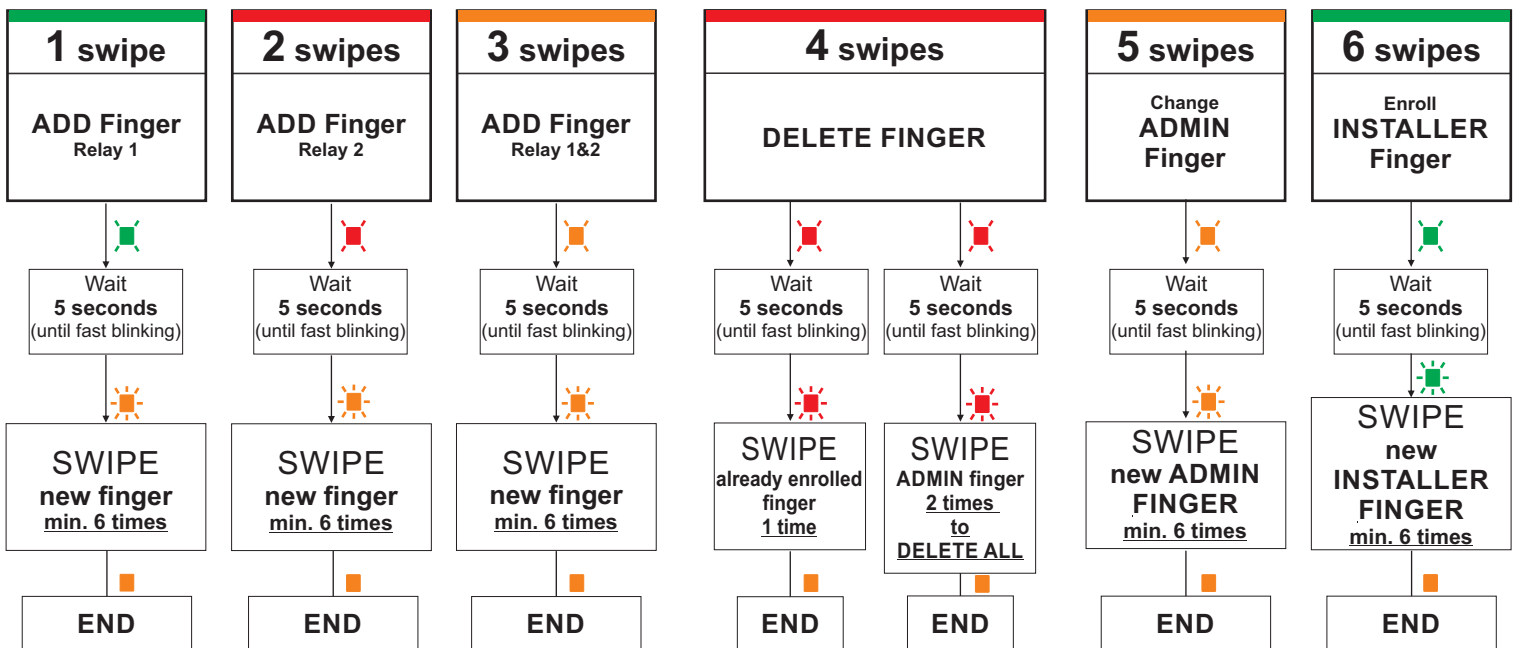



Swipe the **ADMIN** Finger 1 to 6 times depending of the desired menu









Only in combination with DINRTT and RU2



## Set Relay 1 Time





Action	Finger	Backlight	Buzzer Sound
Swipe Installer Finger 1 time	 x 1	 slow blinking	short beep
Wait 5 seconds (until fast blinking)			short beep
Swipe the INSTALLER Finger and start counting seconds	 x 1	 fast blinking	beeps on 1 second
Swipe the INSTALLER Finger to stop or wait 30 seconds to put the relay in toggle mode	 x 1	 fast blinking	short + long beep

## Set Relay 2 Time





Action	Finger	Backlight	Buzzer Sound
Swipe Installer Finger 2 times	 x 2	 slow blinking	short beep
Wait 5 seconds (until fast blinking)			short beep
Swipe the INSTALLER Finger and start counting seconds	 x 1	 fast blinking	beeps on 1 second
Swipe the INSTALLER Finger to stop or wait 30 seconds to put the relay in toggle mode	 x 1	 fast blinking	short + long beep

Relay 2 is available if the reader is used with remote relay unit with 2 relays(DINRTT and RU2). Consult the installer if Relay 2 is available in your system.

## BUZZER ON/OFF

Action	Finger	Backlight	Buzzer Sound
Swipe Installer Finger 3 times	 x 3	 slow blinking	short beep
Wait 5 seconds (until fast blinking)			short beep
Swipe Installer Finger	 x 1	 fast blinking	short + long beep

## BACKLIGHT ON/OFF

Action	Finger	Backlight	Buzzer Sound
Swipe Installer Finger 4 times	 x 4	 slow blinking	short beep
Wait 5 seconds (until fast blinking)			short beep
Swipe Installer Finger	 x 1	 fast blinking	short + long beep

Swipe the **Installer Finger** 1 to 4 times depending of the desired menu

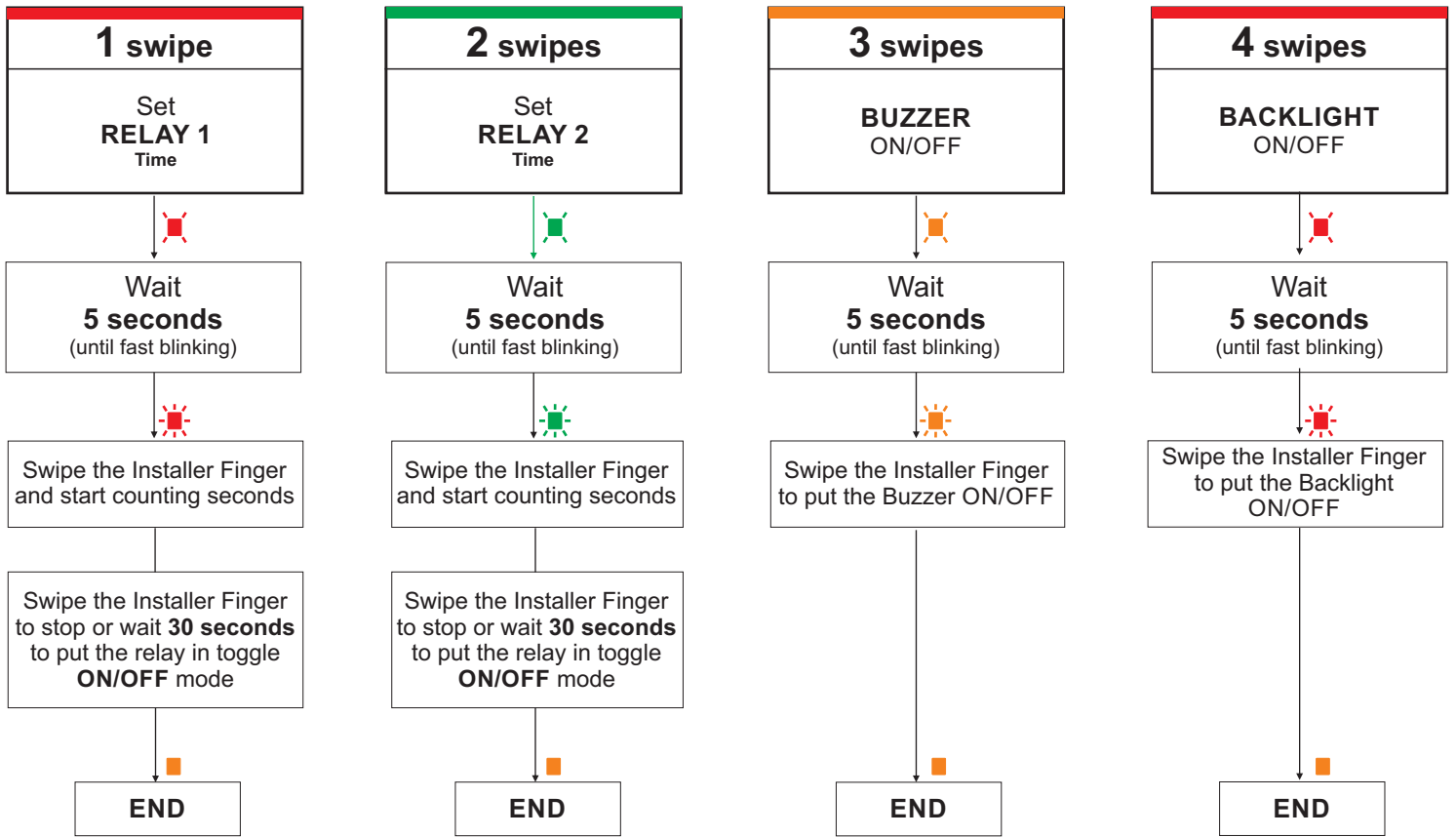

Only in combination with DINRTT and RU2





This product herewith complies with requirements of EMC directive 2014/30/EU. In addition it complies with RoHS directive EN50581:2012



**Northern Office**

Videx Security Ltd  
Unit 4-7 Chillingham ind Est  
Newcastle Upon Tyne  
NE6 2XX  
Tel: 0870 300 1240  
Fax: 0191 224 5678

**Southern Office**

1 Osprey  
Trinity Park  
Trinity Way  
London  
E4 8TD  
Fax: 0208 523 5825