

ART. 6388

6300 Series Hands Free Videophone incorporating a 3.5" Hi-Res full colour active matrix LCD monitor specific for the "True Two wire" 2300 Digital System.

It includes 4 buttons: "answer call/camera recall", "door open", "service" and "privacy".

3 LEDs indicate the call is answered, privacy is activated and door open.

Programmable privacy duration time and number of rings.

Intercommunicating call and door call.

Adjustments: speech volume control, call tone volume switch (3 levels), picture hue, contrast and brightness controls.



6388
Colour Hands Free Videophone
QUICK GUIDE



TECHNICAL SUPPORT
 Tel: 0191 224 3174
 Fax: 0191 224 4938
 Email: tech@videxuk.com
 Web: www.videxuk.com



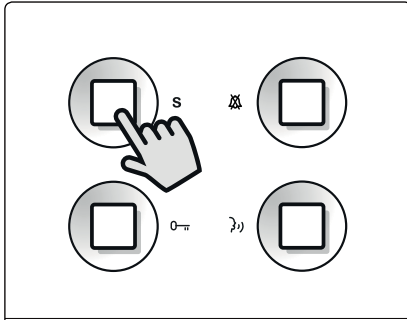
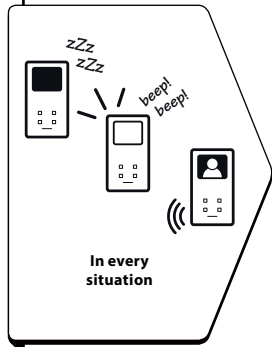

SERVICE BUTTON



Push the service button **S** to activate the secondary service (if this was set up during the installation). To set up the function of the service button, please contact Videx Technical.

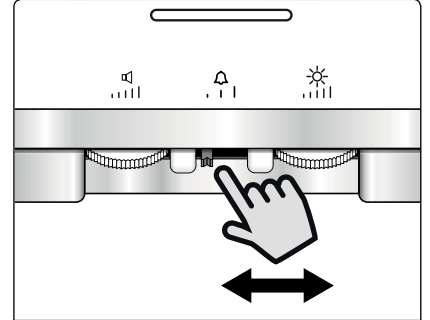
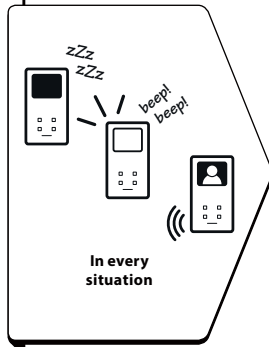

CALL TONE VOLUME ADJUSTMENT

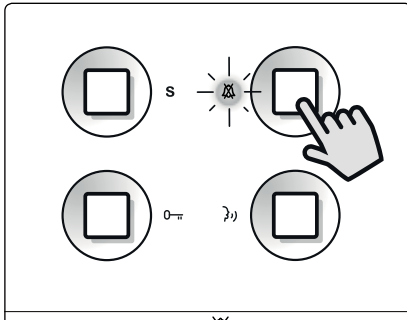
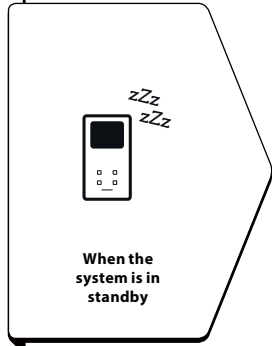

Move the switch, under the call tone symbol  to adjust the call tone volume level. Move to the left for a low call tone level, to the centre for a medium call tone level and to the right for a high call tone level.

PRIVACY FUNCTION



Press the privacy button  to enable the privacy function. The red LED behind the privacy symbol  will illuminate to indicate that the privacy is enabled.



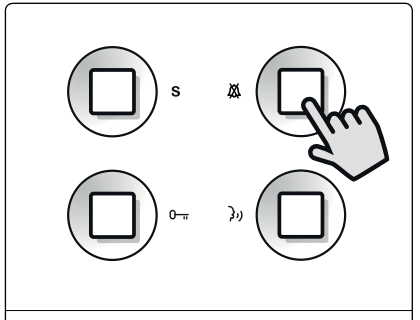

During an incoming call, with the privacy enabled, the videophone will not ring and no picture will be displayed.

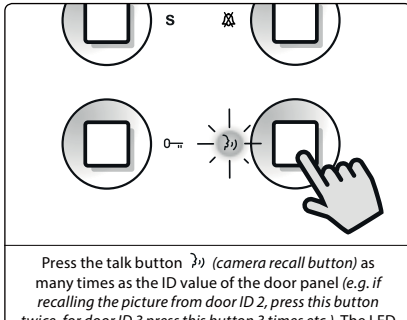
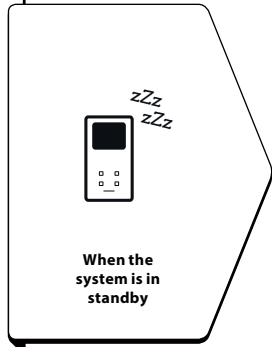

The privacy function will automatically switch OFF after the programmed time expires or by pressing the privacy button  again.

CAMERA RECALL



Press the talk button  (camera recall button) as many times as the ID value of the door panel (e.g. if recalling the picture from door ID 2, press this button twice, for door ID 3 press this button 3 times etc.). The LED behind the talk symbol  will illuminate to indicate the videophone is switched ON. The display will show the picture from the camera on the relevant outdoor station recalled.



During 'Camera Recall' it is possible:

To start a conversation;

To push the lock button  to open the door;

To push the service button **S** to activate the secondary service.

Press the talk button  to end the conversation.

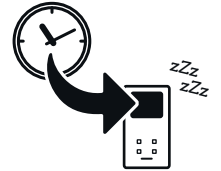

When the conversation time (set up during the installation) has ended, the videophone stops all communication and the system returns to the standby condition.

SPEECH VOLUME ADJUSTMENT

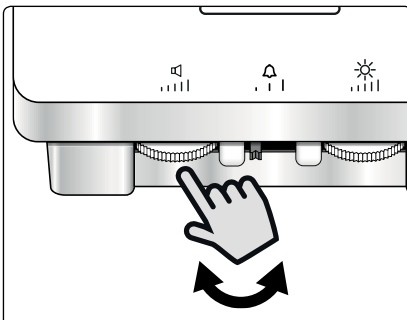
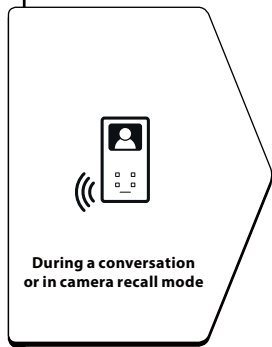

Turn the roller under the speech control symbol  to adjust the volume of speech. Any adjustment to the left will reduce the speech volume and any adjustment to the right will increase the speech volume.

BRIGHTNESS DISPLAY ADJUSTMENT

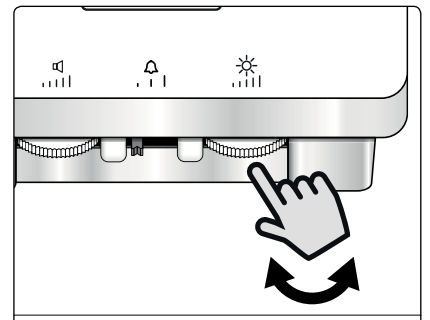
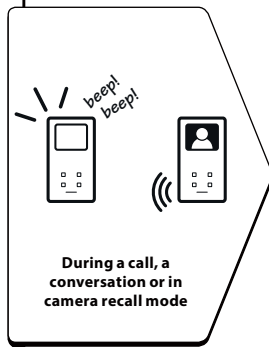

Turn the roller under the brightness control symbol  to adjust the brightness of the picture. Any adjustment to the left will reduce the brightness and any adjustment to the right will increase the brightness.